

**MADER®**

TRABALHA COMO  
UM **PROFISSIONAL**

**MADER®**

**HAND  
TOOLS**

- » ALICATES | ALICATE | PLIER
- » TESOURA LATOEIRO | TIJERA CORTA CHAPA | AVIATION PLIER
- » CORTA TUBOS | CORTATUBOS | PIPE CUTTER
- » ALICATE MULTICAMADA | PRENSA MANUAL-MULTICAPA | MANUAL PRESS PIPE TOOL
- » CHAVE STILSON | LLAVE TIPO STILSON | STILSON PIPE WRENCH
- » CHAVE CRESCENTE | LLAVE AJUSTABLE | ADJUSTABLE WRENCH
- » EXTRATOR PARAFUSOS | EXTRACTOR TORNILLOS | SCREW EXTRACTOR
- » MACHOS E CANÇONETES | MACHOS Y COJINETES | TAP AND DIE SET
- » CHAVE BOCA-LUNETETA | LLAVE COMBINADA | COMBINATION SPANNER
- » CHAVE PARAFUSOS | DESTORNILLADORES | SCREWDRIVER
- » CHAVE DE CAIXA | LLAVES DE VASO | SOCKET TOOL SET
- » MALAS FERRAMENTA SORTIDA | CAJA HERRAMIENTA SURTIDA | ASSORTED HAND TOOL SET
- » VENTOSAS | VENTOSA | SUCTION PAD
- » BANDEJA BORRACHA | BANDEJA GOMA | RUBBER TOOL TRAY
- » O'RINGS | JUNTAS DE GOMA
- » GUIA ELETRICISTA | GUÍA ELECTRICISTA | FISH TAPE
- » MULTIMETRO | MULTIMETER
- » TORNOS | TORNILLOS DE BANCO | BENCH VICE
- » MARTELOS | MARTILLOS | HAMMERS
- » SERROTES | SERRUCHOS | SAWS
- » LIMAS | LIMAS | FILES
- » LIXAS | LIJAS | SANDING PAPERS
- » FACA ALCATIFA | CORTADOR | UTILITY KNIFE
- » MÁQUINAS AGRAFAR | GRAPADORA | STAPLE GUN
- » FITAS MÉTRICAS | FLEXÓMETRO | MEASURING TAPE » PAQUÍMETRO | CALIBRADOR | VERNIER CALIPER
- » NÍVEIS | NIVELES | LEVELS
- » ESQUADROS E RÉGUAS | ESCUADROS Y REGLAS | SQUARE AND RULERS
- » GRAMPOS APERTO | TORNILLO APRIETE | CLAMP
- » PISTOLA ESPUMA | PISTOLA ESPUMA | FOAM GUN
- » MÁQ. MASTIQUE | PISTOLA CARTUCHOS | CAULKING GUN
- » JOELHEIRAS | RODILLERA | KNEE PAD
- » MÁQUINA AZULEJOS | CORTADOR AZULEJOS | TILE CUTTERS
- » BETUMADEIRAS | ESPÁTULAS | SCRAPERS
- » COLHERES | PALETAS | TROWELS
- » TALOCHAS | LLANA | TROWELS
- » MARCADOR RETAS | CORDEL DE TRAZADO | CHALK LINE REEL » FIO PRUMO | HILO PLOMADA | PUMB-LINE
- » GAMELAS » BALDES | BANDEJAS » CUBOS | TRAYS » BUCKETS

Este catálogo apresenta a nossa gama atual. Mudanças no fabrico, forma, design e descrições dos artigos são atualizadas constantemente e pode ser verificado pela versão indicada na pág.. Fotos, descrições e especificações técnicas foram reproduzidas com a maior exatidão possível, sendo possíveis pequenas alterações do original. Os preços constantes no catálogo podem ser alterados sem aviso prévio, devido a alterações de características, aumentos na origem ou diferenças cambiais

Este catálogo presenta nuestra gama actual. Los cambios en la fabricación, los diseños y las descripciones de los artículos se actualizan constantemente y se pueden comprobar en la versión indicada en la pag. . Fotos, descripciones y especificaciones técnicas han sido reproducidos con la máxima exactitud, siendo posibles pequeños cambios en el original. Los precios en el catálogo pueden cambiar sin previo aviso debido a cambios en las características, aumentos en el origen o diferencias cambial.

## ALICATE REBITAR REMACHADORA RIVETING PLIER

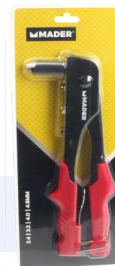

61290



ALUMÍNIO  
ALUMINIUM



61287



61289

## CABEÇA GIRATÓRIA CABEÇA GIRATORIA SWIVEL HEAD



61288

Descrição: Alicate Rebitar  
Marca: Mader Hand Tools

N. Ref.	Especificação	Quant. Caixa:
61290	DY-8113	6/24
61287	DY-8109 - Alumínio	6/24
61289	DY-8112 - Alumínio	6/24
61288	Cabeça Giratória	6/24

**Rebites /Remanches /Rivets :**  
**Alumínio /Aluminio /Aluminium:**  
 2,4 - 3,2 - 4,0 - 4,8mm  
**Inox /Stainless Steel:**  
 2,4 - 3,2 - 4,0mm

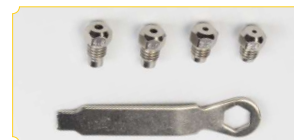

**ALICATE REBITAR**  
**REMACHADORA**  
**RIVETING PLIER**

**TIPO TESOURA | TIPO DE TIJERA | SCISSOR TYPE**



61291

**Rebites /Remanches /Rivets**  
**Alumínio /Aluminio /Aluminium**  
 2,4 - 3,2 - 4,0 - 4,8 - 6,4mm  
**Inox /Stainless Steel:** 2,4 - 3,2 - 4,0 - 4,8m



61286

**Rebites /Remanches /Rivets :**  
**Alumínio /Aluminio /Aluminium:** 3,2 - 4,0 - 4,8 - 6,4mm  
**Inox /Stainless Steel:** 3,2 - 4,0 - 4,8m



Descrição: **Alicate Rebitar**

Marca: **Mader Hand Tools**

N. Ref.	Especificação	Quant. Caixa:
61291	Tipo Tesoura	1/20
61286	JM230 - Tipo Tesoura	1/10

### ALICATE REBITAR PORCAS REMACHADORA TUERCA NUT RIVETING PLIER



5 UN

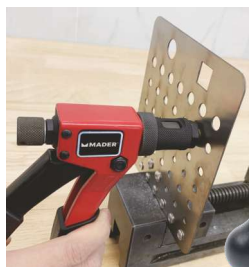

200mm  
M3 - M6



**Tamanho /Tamaño /Size:** 200mm  
**Curso /Working Stroke:** 7mm  
**Adaptadores /Adapters:** M3, M4, M5, M6  
**Chave /Llave /Spaner:** 1 un



8 UN



270mm  
M3 - M12

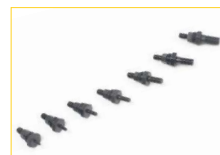

**Tamanho /Tamaño /Size:** 270mm  
**Curso /Working Stroke:** 7mm  
**Adaptadores /Adapters:** M3, M4, M5, M6, M8, M10, M12  
**Chave /Llave /Spaner:** 1 un



78 UN



360mm  
M3 - M12

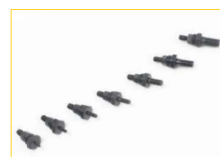

**Tamanho /Tamaño /Size:** 360mm  
**Curso /Working Stroke:** 7mm  
**Adaptadores /Adapters:** M3, M4, M5, M6, M8, M10, M12  
**Porca de Rebite /Tuerca de Remanche /Nut Rivets:** M3 (x10), M4 (x10), M5 (x10), M6 (x10), M8 (x10), M10 (x10), M12 (x10)  
**Chave /Llave /Spaner:** 1 un

Descrição: Alicate Rebitar Porcas

Marca: Mader Hand Tools

N. Ref.	Especificação	Quant.	Caixa:
61292	M3-M6 - 5 un	6	
61293	M3-M12 - 8 un	6	
61294	M3-M12 - 78 un	6	



**PORCAS DE REBITE**  
**TUERCA DE REMACHE**  
**RIVET NUTS**



**M3x9**

**40un**



**M4x11**

**35un**



**M5x13**

**25un**



**M6x15**

**25un**



**M8x18**

**15un**



**M10x21**

**10un**



**M12x21**

**10un**



Descrição: Porca de Rebite

Marca: Mader Hand Tools

N. Ref.	Especificação	Quant. Caixa:
61540	M3 x 9 - 40un	12
61541	M4 x 11 - 35un	12
61542	M5 x 13 - 25un	12
61543	M6 x 15 - 25un	12
61544	M8 x 18 - 15un	12
61545	M10 x 21 - 10un	12
61546	M12 x 21 - 10un	12

## PORCAS DE REBITE TUERCA DE REMACHE RIVET NUTS



**M3 - M10**  
**150 UN**

### Tamanhos /Tamaños /Sizes:

40 un: M3 x 9  
35 un: M4 x 11  
25 un: M5 x 13  
25 un: M6 x 15  
15 un: M8 x 18  
10 un: M10 x 21



Descrição: Porca de Rebite  
Marca: Mader Hand Tools  
N. Ref. Especificação  
61309 M3-M10 - 150 un

Quant. Caixa:  
6

## ADAPTADOR » ALICATE REBITAR PORCAS ADAPTADOR » REMACHADORA TUERCA ADAPTER » NUT RIVETING PLIER



**M3**

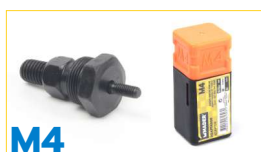

**M4**

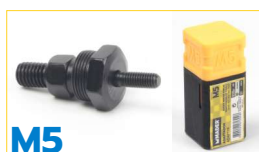

**M5**



**M6**



**M8**



Descrição: Adaptador » Alicates Rebitar Porcas

Marca: Mader Hand Tools

N. Ref.	Especificação	Quant. Caixa:
61302	M3	6
61303	M4	6
61304	M5	6
61305	M6	6
61306	M8	6
61307	M10	6
61308	M12	6



**M10**



**M12**





CHROME VANADIUM

**ALICATE**  
ALICATE  
PLIER



**UNIVERSAL**  
COMBINATION



**6"**  
160mm



**7"**  
180mm



**8"**  
200mm



**CORTE LATERAL**  
CORTE DIAGONAL  
DIAGONAL CUT



**6"**  
160mm



**7"**  
180mm



**BOMBA D'ÁGUA**  
PICO LORO  
WATER PUMP



**250mm**



**300mm**



Descrição: Alicate - C.V.

Marca: Mader Hand Tools

N. Ref. Especificação Quant. Caixa:

57720	Universal - 6" - 160mm	6/60
57722	Universal - 7" - 180mm	6/60
57724	Universal - 8" - 200mm	6/60
57735	Corte Lateral - 6" - 160mm	6/60
57737	Corte Lateral - 7" - 180mm	6/60
57768	Bomba d'Água - 250mm	6/36
57769	Bomba d'Água - 300mm	6/36
57738	Descarnar Fio - 6" - 160mm	6/60

**DESCARNAR FIO**  
PELACABLES  
WIRE STRIPPING



**6"**  
160mm





**ALICATE**  
ALICATE  
PLIER

**CHROME VANADIUM**



**6"**  
160mm

**PONTA REDONDA**  
PUNTA REDONDA  
ROUND NOSE



**PONTA DIREITA**  
PUNTA RECTA  
LONG NOSE



**6"**  
160mm



**8"**  
200mm



Descrição: Alicate - C.V.

Marca: Mader Hand Tools

N. Ref.	Especificação	Quant. Caixa:
57726	Pontas Redonda - 160mm	6/60
57728	Pontas Direita - 160mm	6/60
57730	Pontas Direita - 200mm	6/60
57732	Pontas Curva - 200mm	6/60

**PONTA CURVA**  
PUNTA CURVA  
BENT NOSE



**8"**  
200mm

**ALICATE**  
ALICATE  
PLIER

**CHROME VANADIUM**



**8"**  
200mm

EN 60900:2004  
**1000Volts**



**ISOLADO**  
AISLADO  
INSULATED

**UNIVERSAL**  
COMBINATION



**PONTA CURVA**  
PUNTA CURVA  
BENT NOSE

Descrição: Alicate - Isolado - C.V.

Marca: Mader Hand Tools

N. Ref.	Especificação	Quant. Caixa:
61265	Universal - 8" - 200mm	6
61268	Pontas Curvas - 8" - 200mm	6

**ALICATE**  
ALICATE  
PLIER

**PONTA DIREITA / PUNTA RECTA / STRAIGHT TIP**  
**CORTE LATERAL / SIDE CUT**  
**UNIVERSAL**



**3un**



175mm

**BOMBA ÁGUA**  
PICO LORO  
WATER PUMP

**COM BOLSA**  
WITH POUCH



**3un**



175-250-300mm

**FIXAÇÃO**  
MORDAZA  
LOCK WRENCH

**COM BOLSA**  
WITH POUCH



**AÇO CARBONO**  
ACERO CARBONO  
CARBON STEEL



**4un**



125-165-175-250mm

**MULTIFUNÇÕES**  
MULTIFUNCIÓN  
MULTIFUNCTION



**X-ATO**  
CUCHILLO  
KNIFE



Descrição: Alicate

Marca: Mader Hand Tools

N. Ref.	Especificação	Quant.	Caixa:
52133	Sortidos - 175 mm - 3 un.	5/30	
57775	Bomba d' Água - 3 un.	5/30	
61295	Fixação - 4 un.	5/30	
57776	Multifunções c/ X-Ato	12	

**1un. - Alicate Multifunções**  
/Alicate Multifunción /Multifunction Plier

**1un. - Bolsa de Nylon**  
/Bolsa de Nylon /Nylon Bag

**1un. - X-ato Desdobrável**  
/Cuchillo Despegable /Folding Knife

**5un. - Lâminas**  
/Láminas /Blades



**Bolsa de Nylon**  
Nylon Bag

### TURQUEZ TENAZA PINCERS

**CABO REVESTIDO | MANGO RECUBIERTO | DIPPING HANDLE**



**225mm**



**250mm**



**PROFISSIONAL**

**CHROME  
VANADIUM**

Descrição:	Turquez - C.V.	
Marca:	Mader Hand Tools	
N. Ref.	Especificação	Quant. Caixa:
61090	c/ Revestimento - 225mm	10/60
61091	c/ Revestimento - 250mm	6/48

### TESOURA LATOEIRO TIJERA CORTA CHAPA AVIATION PLIER

**CHROME VANADIUM**



**FRENTE  
DELANTERO  
STRAIGHT**



**DIREITA  
DERECHA  
RIGHT CUT**



**ESQUERDA  
IZQUIERDA  
LEFT CUT**



**250mm**



**250mm**



**250mm**

Descrição:	Tesoura Latoeiro	
Marca:	Mader Hand Tools	
N. Ref.	Especificação	Quant. Caixa:
61281	Corte Frente - 250 mm	10
61283	Corte Direita - 250 mm	10
61282	Corte Esquerda - 250 mm	10

### ESCAREADOR TIPO CANETA ESCARIADOR LAPICERA PEN REAMER



**5** LÂMINAS  
CUCHILLAS  
BLADES

Descrição:	Escareador tipo Caneta	Quant. Caixa:	24
Marca:	Mader Hand Tools		
N. Ref. Especificação	61455 5 Lâminas		

### CABEÇA » ALICATE para MULTICAMADA CABEZA » PRENSA MANUAL para MULTICAPA HEAD » MANUAL PRESS PIPE TOOL

para **57899**



**16mm**



**20mm**



**25mm**



**32mm**

Descrição:	Cabeça p/ Alicate Multicamada - 57899	Quant. Caixa:	
Marca:	Mader Hand Tools		
N. Ref. Especificação	57696 16 mm	1	
	57697 20 mm	1	
	57698 25 mm	1	
	57699 32 mm	1	



### CABEÇA » ALICATE para MULTICAMADA CABEZA » PRENSA MANUAL para MULTICAPA HEAD » MANUAL PRESS PIPE TOOL

para **58060**



**12mm**



**16mm**



**20mm**



**25mm**

Descrição:	Cabeça p/ Alicate Multicamada - 58060	Quant. Caixa:	
Marca:	Mader Hand Tools		
N. Ref. Especificação	58061 12 mm	1	
	58062 16 mm	1	
	58063 20 mm	1	
	58064 25 mm	1	



**ALICATE » MULTICAMADA**  
**PRENSA MANUAL » MULTICAPA**  
**MANUAL PRESS PIPE TOOL**



**5un**  
**12-16-20-25mm**



**CHROME VANADIUM**



**5un**  
**16-20-25-32mm**

Extensível  
 350 a 580 mm

Descrição: Alicate p/ Multicamada

Marca: Mader Hand Tools

N. Ref.	Especificação	Quant.	Caixa:
58060	12-16-20-25mm - 5un	1	
57899	16-20-25-32 mm - 5 un - Extens.	4	



### CHAVE STILSON LLAVE TIPO STILSON STILSON PIPE WRENCH

**ALUMÍNIO**  
ALUMINIO  
ALUMINUM



Descrição: Chave Stilson - Alumínio

Marca: Mader Hand Tools

N. Ref. Especificação

N. Ref.	Especificação	Quant. Caixa:
88820	14"	2
88821	18"	2
88822	24"	2



**14"**

350mm



**18"**

450mm



**24"**

600mm

### CABO REVESTIDO MANGO RECUBIERTO DIPPING HANDLE



Descrição: Chave Stilson - c/ Isolamento

Marca: Mader Hand Tools

N. Ref. Especificação

N. Ref.	Especificação	Quant. Caixa:
57712	10"	6
57713	12"	4
57714	14"	4
57715	18"	4
57716	24"	4
57717	36"	2
57718	48"	2



**12"**

300mm



**14"**

350mm



**18"**

450mm



**24"**

600mm



**36"**

900mm



**48"**

1200mm

### CHAVE TIPO SUECO LLAVE TIPO SUECA SWEDISH PIPE WRENCH

**CHROME VANADIUM**



Descrição: Chave Tipo Sueco

Marca: Mader Hand Tools

N. Ref. Especificação

N. Ref.	Especificação	Quant. Caixa:
57748	1"	6
57750	1 - 1/2"	4
57752	2"	4



**1"**

25mm



**1-1/2"**

38mm



**2"**

50mm

### CHAVE CRESCENTE LLAVE AJUSTABLE ADJUSTABLE WRENCH



**GRADUADA  
GRADUADO  
GRADUATED**

Descrição: Chave Crescente

Marca: Mader Hand Tools

N. Ref.	Especificação	Quant.	Caixa:
61190	Borracha - 200mm	12	
61191	Borracha - 250mm	6	
61192	Borracha - 300mm"	6	

### CABO REVESTIDO MANGO RECUBIERTO DIPPING HANDLE



**8"**  
200mm



**10"**  
250mm



**12"**  
300mm

### CHAVE COM CORRENTE LLAVE DE CADENA CHAIN WRENCH



**610mm**



Descrição: Chave c/ Corrente

Marca: Mader Hand Tools

N. Ref.	Especificação	Quant.	Caixa:
57762	610 mm	5	

### EXTRATOR DE PARAFUSOS EXTRACTOR DE TORNILLOS SCREW EXTRACTOR

- 1/8" - 1/4"
- 1/4" - 5/16"
- 5/16" - 7/16"
- 7/16" - 9/16"
- 9/16" - 3/4"



**5un**



Descrição: Extrator de Parafusos

Marca: Mader Hand Tools

N. Ref.	Especificação	Quant.	Caixa:
61110	5un	25	

## DESANDADOR TERRAJA ROUND HANDLE



**DESANDADOR » CAÇONETES**  
TERRAJA » COJINETES  
ROUND HANDLE » DIE

1"



**DESANDADOR » MACHOS**  
TERRAJA » MACHOS  
ROUND HANDLE » TAP

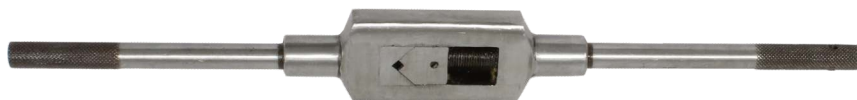

1/2"

1"



Descrição: Desandador

Marca: Mader Hand Tools

N. Ref. Especificação

63079 Caçonetes - 1"

63077 Machos - 1/2"

63078 Machos - 1"

Quant. Caixa:

10

5

5

## MACHOS E CAÇONETES MACHOS Y COJINETES TAP AND DIE SET



13un

Descrição: Machos e Caçonetes

Marca: Mader Hand Tools

N. Ref. Especificação

63075 13 un

Quant. Caixa:

10

**Machos /Machos /Tap :** 6 un

M3x0.5; M4x0.7; M5x0.8; M5x0.9; M6x1.0; M8x1.25

**Caçonetes /Cojinetes /Die:** 6 un

M3x0.5; M4x0.7; M5x0.8; M5x0.9; M6x1.0; M8x1.25

**Chave /Llave /Wrench:** 1 un

## MACHOS E CAÇONETES MACHOS Y COJINETES TAP AND DIE SET



20un

Descrição: Machos e Caçonetes

Marca: Mader Hand Tools

N. Ref. Especificação

61118 20 un

Quant. Caixa:

1

**Machos /Machos /Tap :** 9 un

M3x0.5; M4x0.7; M5x0.8; M6x1.0; M7x1.0; M8x1.25; M9x1.25; M10x1.5; M12x1.75

**Caçonetes /Cojinetes /Die:** 9 un

M3x0.5; M4x0.7; M5x0.8; M6x1.0; M7x1.0; M8x1.25; M9x1.25; M10x1.5; M12x1.75

**Desandador /Terraça /Wrench** 2 un

Machos /Machos /Tap

M3-M12

Caçonetes /Cojinetes /Die

25mm



## MACHOS E CAÇONETES MACHOS Y COJINETES TAP AND DIE SET



**25un**



Descrição: Machos e Caçonetes

Marca: Mader Hand Tools

N. Ref. Especificação  
63076 25 un

Quant. Caixa:  
10

**Machos /Machos /Tap :** **12 un**  
5/16NC18; 1/4NC20; 12NC24; 10NC24; 8NC32; 6NC32  
M3x0.5; M4x0.7; M5x0.8; M5x0.9; M6x1.0; M8x1.25

**Caçonetes /Cojinetes /Die:** **12 un**  
5/16NC18; 1/4NC20; 12NC24; 10NC24; 8NC32; 6NC32  
M3x0.5; M4x0.7; M5x0.8; M5x0.9; M6x1.0; M8x1.25

**Chave /Llave /Wrench:** **1 un**

## MACHOS E CAÇONETES MACHOS Y COJINETES TAP AND DIE SET



**32un**

Descrição: Machos e Caçonetes

Marca: Mader Hand Tools

N. Ref. Especificação  
61106 32 un

Quant. Caixa:  
10

**Machos /Machos /Tap :** **21 un**  
Cônico /Conico /Taper  
M3x0.5; M4x0.7; M5x0.8; M6x1; M8x1.25; M10x1.5;  
M12x1.75  
Ponto /Punto /Pulg  
M3x0.5; M4x0.7; M5x0.8; M6x1; M8x1.25; M10x1.5;  
M12x1.75  
Direito /Derecho /Bottom  
M3x0.5; M4x0.7; M5x0.8; M6x1; M8x1.25; M10x1.5;  
M12x1.75

**Caçonetes /Cojinetes /Die:** **7 un**  
M3x0.5; M4x0.7; M5x0.8; M6x1; M8x1.25; M10x1.5;  
M12x1.75

**Desandador /Terraça /Wrench** **3 un**  
Machos /Machos /Tap  
M3; M12  
Caçonetes /Cojinetes /Die  
25mm

**Chave /Llave /Wrench:** **1 un**  
**Escantilhão de Roscas:** **1 un**  
/Patrón Roscas /Screwdriver Pitch Gauge

### CHAVE 2 BOCAS LLAVE 2 BOCAS DOUBLE OPEN END SPANNER

### PROFISSIONAL CHROME VANADIUM



6mm x 7mm



8mm x 9mm



10mm x 11mm



12mm x 13mm



14mm x 15mm



16mm x 17mm



18mm x 19mm



20mm x 22mm

Descrição: Chave 2 Bocas  
Marca: Mader Hand Tools

N. Ref.	Especificação	Quant. Caixa:
57862	6 x 7 mm	10
57866	8 x 9 mm	10
57868	10 x 11 mm	10
57870	12 x 13 mm	10
57872	14 x 15 mm	10
57874	16 x 17 mm	10
57876	18 x 19 mm	10
57878	20 x 22 mm	10
57880	21 x 23 mm	10
57882	24 x 26 mm	10
57883	24 x 27 mm	10
57884	25 x 28 mm	10
57888	30 x 32 mm	10



21mm x 23mm



24mm x 26mm



24mm x 27mm



25mm x 28mm



30mm x 32mm



8un

6x7, 8x9, 10x11, 12x13,  
14x15, 16x17, 18x19,  
20x22 mm



12un

6x7, 8x9, 10x11, 12x13,  
14x15, 16x17, 18x19,  
20x22, 21x23, 24x26,  
25x28, 30x32 mm

Descrição: Chaves 2 Bocas  
Marca: Mader Hand Tools

N. Ref.	Especificação	Quant. Caixa:
59550	8 un	20
59551	12 un	12



### CHAVE LUNETA LLAVE ACODADA DOUBLE RING SPANNER

### PROFISSIONAL CHROME VANADIUM



6mm x 7mm



8mm x 9mm



10mm x 11mm



12mm x 13mm



14mm x 15mm



16mm x 17mm



18mm x 19mm



20mm x 22mm

Descrição: Chave Luneta

Marca: Mader Hand Tools

N. Ref.	Especificação	Quant. Caixa:
57786	6 x 7 mm	10
57788	8 x 9 mm	10
57790	10 x 11 mm	10
57792	12 x 13 mm	10
57794	14 x 15 mm	10
57796	16 x 17 mm	10
57798	18 x 19 mm	10
57800	20 x 22 mm	10
57802	21 x 23 mm	10
57804	24 x 26 mm	10
57806	25 x 28 mm	10
57808	27 x 29 mm	10
57810	30 x 32 mm	10



21mm x 23mm



24mm x 26mm



25mm x 28mm



27mm x 29mm



30mm x 32mm



8un

6x7, 8x9, 10x11, 12x13,  
14x15, 16x17,  
18x19, 20x22 mm



12un

6x7, 8x9, 10x11, 12x13,  
14x15, 16x17, 18x19,  
20x22, 21x23, 24x26,  
25x28, 30x32 mm

Descrição: Chaves Luneta

Marca: Mader Hand Tools

N. Ref.	Especificação	Quant. Caixa:
59558	8 un	20
59559	12 un	12



**CHAVE BOCA-LUNETA**  
LLAVE COMBINADA  
COMBINATION SPANNER



**PROFISSIONAL**  
**CHROME VANADIUM**



**12mm**



**16mm**



**6mm**



**9mm**



**13mm**



**17mm**



**7mm**



**10mm**



**14mm**



**18mm**



**8mm**



**11mm**



**15mm**



**19mm**



**20mm**



**23mm**



**26mm**



**29mm**



**21mm**



**24mm**



**27mm**



**30mm**



**22mm**



**25mm**



**28mm**



**32mm**

Descrição: Chave Boca/Luneta

Marca: Mader Hand Tools

N. Ref.	Especificação	Quant. Caixa:
57812	6 mm	10
57814	7 mm	10
57816	8 mm	10
57818	9 mm	10
57820	10 mm	10
57822	11 mm	10
57824	12 mm	10
57826	13 mm	10
57828	14 mm	10
57830	15 mm	10
57832	16 mm	10
57834	17 mm	10
57836	18 mm	10
57838	19 mm	10
57840	20 mm	10
57842	21 mm	10
57844	22 mm	10
57846	23 mm	10
57848	24 mm	10
57850	25 mm	10
57852	26 mm	10
57854	27 mm	10
57856	28 mm	10
57858	29 mm	10
57860	30 mm	10
57861	32 mm	10

**CHAVE BOCA-LUNETA**  
LLAVE COMBINADA  
COMBINATION SPANNER

**PROFISSIONAL**  
**CHROME VANADIUM**



**8un**



8, 9, 10, 11, 13, 14,  
17, 19 mm



**12un**

6, 7, 8, 9, 10, 11, 12, 13,  
14, 17, 19, 22 mm



Descrição: Chaves Boca - Luneta

Marca: Mader Hand Tools

N. Ref. Especificação

59555 8 un

59556 12 un

Quant. Caixa:

20

12

**CHAVE BOCA-LUNETA**  
LLAVE COMBINADA  
COMBINATION SPANNER

**CHROME VANADIUM**

**C/ ROQUETE - ARTICULADO**  
**C/ CARRACA - ARTICULADA**  
**W/ RATCHET - REMOVABLE**



**8mm**  
**10mm**  
**13mm**  
**14mm**  
**17mm**



**5un**

Descrição: Chave Boca/Luneta c/ Roquete

Marca: Mader Hand Tools

N. Ref. Especificação  
61301 Articulado - 5 un

Quant. Caixa:

10

**CHAVE DE PARAFUSOS**  
**LLAVES DE DESTORNILLADORES**  
**SCREWDRIVER**

### Chrome-Vanadium

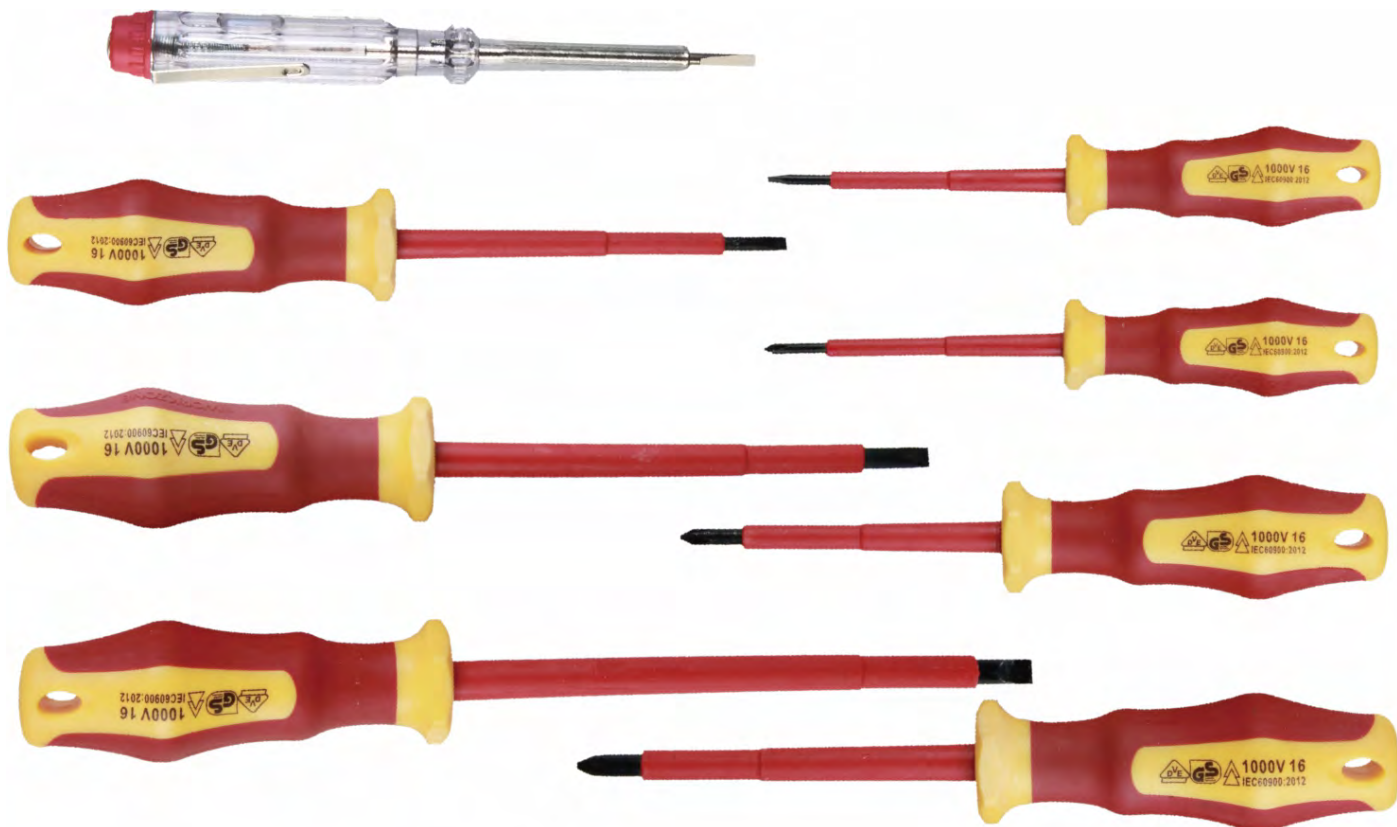

**Chave Busca-Pólos: 140mm**

**Chaves: 7un - 3x0.5x75mm; 4x0.8x100mm; 5.5x1.0x125mm; 6.5x1.2x150mm; PH0x75mm; PH1x80mm; PH2x100mm;**

Buscapolos: 140mm

Chaves: 7un - 3x0.5x75mm; 4x0.8x100mm; 5.5x1.0x125mm; 6.5x1.2x150mm; PH0x75mm; PH1x80mm; PH2x100mm;

Voltage Tester: 140mm

Screwdrivers: 7un - 3x0.5x75mm; 4x0.8x100mm; 5.5x1.0x125mm; 6.5x1.2x150mm; PH0x75mm; PH1x80mm; PH2x100mm;

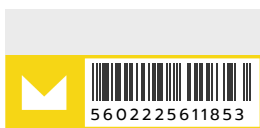

**VDE**  
8 un

N. Ref.	Descrição	Marca	Quant. Caixa
61185	CH PARAFUSOS-MHT-VDE 8PC	MADER HAND TOOLS	10

### CHAVE PARAFUSOS DESTORNILLADORES SCREWDRIVER

- ⊖ 3.0 x 75 mm  
4.0 x 100 mm  
5.0 x 125 mm  
6.0 x 150 mm  
8.0 x 200 mm
- ⊕ PH 0 x 75 mm  
PH 0 x 100 mm  
PH 1 x 125 mm  
PH 2 x 150 mm



CHROME VANADIUM



9un



Descrição: Chave Parafusos Sortida

Marca: Mader Hand Tools

N. Ref. Especificação  
52134 Cabo Borracha - 9 un

Quant. Caixa:  
20

### CHAVE PARAFUSOS DESTORNILLADORES SCREWDRIVER



CHROME VANADIUM



10un

MAGNÉTICA  
MAGNÉTICA  
MAGNETIC



Descrição: Chave Parafusos

Marca: Mader Hand Tools

N. Ref. Especificação  
61132 Vermelha/Preta - 10 un

Quant. Caixa:  
10

- ⊖ 3 x 75 mm  
4 x 100 mm  
5 x 125 mm  
6 x 100 mm  
6 x 38 mm

- ⊕ PH 0 x 75 mm  
PH 1 x 100 mm  
PH 1 x 125 mm  
PH 2 x 100 mm  
PH 2 x 38 mm

### MALA FERRAMENTA SORTIDA MALETIN DE HERRAMIENTA SURTIDA HAND TOOL SET



- 11un Chaves /Llaves /Wrench
- 4un Chaves Precisão /Llaves de Precisión /Precision Wrench
- 25un Bits /Puntas
- 18un Chaves Caixa /Llaves Vaso /Socket
- 1un Adaptador Bits /Adaptador Puntas /Bits Adapter
- 1un Extensão Flexível /Mango Articulado /Flexible Extension

Descrição: Mala Ferramenta Sortida

Marca: Mader Hand Tools

N. Ref. Especificação  
52135 60 un

Quant. Caixa:  
10



60UN



### CHAVE BUSCA-PÓLOS DESTORNILLADOR NEON BUSCAPOLOS VOLTAGE TESTER SCREWDRIVER



**140mm**  
AC - 100 - 500V



140 mm



190 mm



210 mm



**2un**

Descrição: Chave Busca - Pólos

Marca: Mader Hand Tools

N. Ref.	Especificação	Quant. Caixa:
83214	140 mm	20
83213	190 mm	20
83216	210 mm	20
83215	140 mm + 190 mm - 2 un.	20



**190mm**  
AC-120-250V



**210mm**  
AC-100-500V



**140 + 190mm**  
AC-100-500V

### CHAVE SEXTAVADA + TORX LLAVE HEXAGONAL + TORX HEX + TORX KEY WRENCHES

**CHROME VANADIUM**



**16 un**

Descrição: Chave Sextavada + Torx

Marca: Mader Hand Tools

N. Ref.	Especificação	Quant. Caixa:
61120	C.V. - 16 un	5

⦿ (75mm) E2, E2.5, (100mm) E3, E4, (150mm) E5, E6, (200mm) E8, E10 (SEXT)

⦿ (75mm) T10, T15, (100mm) T20, T25, (150mm) T30, T40, (200mm) T45, T50 (TORX) **COM FURO | CON ORIFICIO | WITH HOLE**



### CHAVE TORX LLAVE TORX TORX KEY

COM ADAPTADOR  
CON ADAPTADOR  
WITH ADAPTER



9 un

T10, T15, T20, T25, T27, T30, T40, T45, T50

COM FURO  
CON ORIFICIO  
WITH HOLE



### LONGAS /LARGAS /LONG

CHROME VANADIUM

### CHAVE TORX LLAVE TORX TORX KEY



9 un

COM FURO  
CON ORIFICIO  
WITH HOLE

T10, T15, T20, T25,  
T27, T30, T40, T45,  
T50



### CHAVE SEXTAVADA LLAVE HEXAGONAL HEX KEY WRENCHES



9 un

E1,5, E2, E2,5, E3, E4,  
E5, E6, E8, E10

Descrição: Chave

Marca: Mader Hand Tools

N. Ref.	Especificação	Quant. Caixa:
57529	Torx c/ Adaptador - 9 un	10
61170	Torx Longa CVR - 9 un	10
61160	Sextavada Longa CVR - 9 un	10

### KIT REPARAÇÃO - BICICLETA KIT REPARACIÓN - BICICLETAS REPAIR TOOL KIT - BICYCLE

Chave de Aperto /Llave Apriete /Spanner: 8, 10, 15mm  
Chaves Caixa /Llaves Vaso /Sockets: - Hex: 8, 9, 10,mm  
Adaptador Universal /Universal Adaptor  
Chaves /Destronillador /Screwdrivers:  
Plana-flat, Phillips, Hex 2, 2,5, 3, 4, 5, 6mm  
Bolsa /Estuche /Storage Pouch  
Espátula Pneus /Palanca Neumáticos /Tyre Levers  
Tubo Cola /Tubo de Adhesivo /Glue  
Remendos /Parches | Patches: 35x50, 25x35, 28x28mm

Descrição: Kit Bicicleta

Marca: Mader Hand Tools

N. Ref.	Especificação	Quant. Caixa:
16031	p/ Reparação	6



### BITS PUNTAS BITS



25mm | 6un

CHROME MOLYBDENUM



⊕ PH1



⊕ PH2



⊕ PH3



⊛ T15



⊛ T20



⊛ T27



50mm | 6un



⊕ PH2



⊛ PZ1



⊛ PZ2



⊛ PZ3



⊛ PZ2

Descrição: Bits

Marca: Mader Hand Tools

N. Ref.	Especificação	Quant. Caixa:
61312	6 un - PH1 x 25mm	24
61313	6 un - PH2 x 25mm	24
61314	6 un - PH3 x 25mm	24
61315	6 un - T15 x 25mm	24
61316	6 un - T20 x 25mm	24
61317	6 un - T27 x 25mm	24
61318	6 un - PZ1 x 25mm	24
61319	6 un - PZ2 x 25mm	24
61320	6 un - PZ3 x 25mm	24
61310	6 un - PH2 x 50mm	24
61311	6 un - PZ2 x 50mm	24
57620	10 un - Torx - 50mm	12

### TORX

CHROME VANADIUM



50mm  
10un

⊛ T6, T7, T8, T9, T10, T15, T20, T25, T27, T30



### BITS COM ADAPTADOR PUNTAS CON ADAPTADOR BITS WITH DRIVER



14 un



Composição / Composición / Composition

SL3, SL4, SL5,  
PH1, PH2, PH3,  
PZ1, PZ2, PZ3,  
T10, T15, T20, T25, T30

Acessórios / Accesorios / Accessories

Adaptador - 1 un

N. Ref.	Descrição	Marca	Quant. Caixa
61096	BIT'S SORT-MHT-15UN	MADER HAND TOOLS	10

**BITS » CHAVES DE CAIXA**  
**PUNTAS » LLAVES DE VASO**  
**BITS » NUTSETTER**

**MAGNÉTICO | MAGNETIC**



7mm



8mm



9mm



10mm



11mm



12mm



13mm



6, 8, 10, 12mm

**25mm | 4un**



5, 6, 8, 10, 11, 13mm

**25mm | 6un**

Descrição: Bits » Chaves de Caixa

Marca: Mader Hand Tools

N. Ref.	Especificação	Quant. Caixa:
61700	7mm	1
61701	8mm	1
61702	9mm	1
61703	10mm	1
61704	11mm	1
61705	12mm	1
61706	13mm	1

51192 4 un - 6, 8, 10, 12mm 10/60

51189 6 un - 5, 6, 8, 10, 11, 13mm 1

### BITS PUNTAS BITS

### ADAPTADOR MAGNÉTICO ADAPTADOR MAGNÉTICO MAGNETIC DRIVER

CHROME VANADIUM



26UN



Descrição: Bits  
 Marca: Mader Hand Tools  
 N. Ref. Especificação Quant. Caixa:  
 61095 c/ Adaptador C.V. - 26 un 12

- ⊕ PH1 (x4), PH2 (x4), PH3 (x4)
- ⊗ PZ1 (x4), PZ2 (x4)
- ⊙ T8, T10, T15, T20, T25

### BITS PUNTAS BITS

CHROME VANADIUM



- ⊖ 3, 4, 5, 6mm
- ⊕ PH0(x2), PH1(x2), PH2(x3), PH3(x2)
- ⊗ PZ0, PZ1(x2), PZ2(x3), PZ3(x2)
- ⊙ 15, 2, 2.5, 3, 4, 4.5, 5.5, 6mm, 1/16", 5/64", 3/32", 7/64", 1/8", 9/64", 5/32", 3/16", 7/32", 1/4"
- ⊙ 2, 2.5, 3, 4, 5, 6mm, 5/64", 3/32", 7/64", 1/8", 9/64", 5/32"
- ⊙ T8, T10(x2), T15(x2), T20(x2), T25(x2), T27, T30, T40, T45
- ⊙ T8H, T10H, T15H, T20H, T25H, T27H, T30H, T40H, T45H
- ⊙ M5, M6, M8      ⊙ S0, S1, S2, S3
- ⊕ 6, 8, 10      ⊕ 1, 2, 3, 4
- ⊖ 4, 6, 8, 10      ⊕ C1, C2, C3

- 1un Roquete /Carraca /Ratchet
- 1un Extensão Magnético /Extensión Magnética /Magnetic Extension
- 1un Adapt. Chave Caixa /Adaptad. Llave Vaso /Socket Adapter
- 2un Adaptador Bits /Adapter Puntas /Bits Adapter 25, 50mm
- 1un Bit em Y /Punta en Y /Wing Adapter



101 UN  
25mm

Descrição: Bits  
 Marca: Mader Hand Tools  
 N. Ref. Especificação Quant. Caixa:  
 61102 Sortidos - C.V. - 101 un 10

**ADAPTADOR » BITS**  
**ADAPTADOR » PUNTAS**  
**QUICK RELEASE BIT HOLDER**



**MAGNÉTICO**



**2un**  
**60mm + 150mm**



Descrição:	Adaptador p/ Bits		
Marca:	Mader Hand Tools		
N. Ref.	Especificação	Quant. Caixa:	
51198	2 un - 60+150 mm	30	

**ADAPTADOR P/ CHAVES DE CAIXA**  
**ADAPATADOR P/ LLAVE DE VASO**  
**SOCKET ADAPTERS**



**CHROME VANADIUM**



**6un**



- 1/4" x 3/8"
- 3/8" x 1/2"
- 3/8" x 1/4"
- 1/2" x 3/8"
- 3/4" x 1/2"
- 1/2" x 3/4"

**IMPACTO**

**OSCILANTE / AJUSTÁVEL**



**3un**

- 1/4"
- 3/8"
- 1/2"

Descrição:	Kit Adaptadores		
Marca:	Mader Hand Tools		
N. Ref.	Especificação	Quant. Caixa:	
59581	Redutor / Extensor - 6 un	24	
61109	Impacto / Oscilante - 3 un	24	

**ROQUETE**  
CARRACA  
RATCHET HANDLE

**OSCILANTE / AJUSTÁVEL**



**PROFISSIONAL**

**ALTA QUALIDADE**



**CHROME VANADIUM**

**72 Dentes**

Descrição: Roquete

Marca: Mader Hand Tools

N. Ref. Especificação

57631 1/4" - 72D - Profissional

Quant. Caixa:

25

57633 1/2" - 72D - Profissional

10



5460222545763121

**1/4"**



5460222545763361

**1/2"**

**CHAVE DINAMOMÉTRICA**  
LLAVE TORSIÓN  
TORQUE WRENCH



**1/4"**  
10un

**1/2"**  
1un

**1/2"**  
6un

**REVERSÍVEL / REVERSIBLE**



5460222546116551



5460222546116791



5460222546116621

**Roquete / Carraca / Ratchet:**

1/4" - 270mm

1/2" - 460mm

1/2" - 470mm

Reversível / Reversible / Reversible

**Chaves Rodas / Llaves Ruedas / Wheel Socket:**

x

x

17, 19, 21mm

**Extensão / Prolongador / Extension:**

x

x

1/2" - 125mm

**Redutor / Reductor / Reducer:**

x

x

1/2"x3/8"

**Chaves Caixa / Llaves Vaso / Socket:**

1/4" - H2.5, H3, H4, H5,  
H6, H8, H10, T25, T30

x

x

**Torque Máx. / Torque Máx. / Max. Torque:**

2.26 - 22.6Nm

28-210Nm

42-210Nm

**Precisão / Precisión / Accurate: (Dentro-Within)**

+/- 4%

+/- 4%

+/- 4%

**Peso / Weight:**

0.9Kg

1.36Kg

1.7Kg

Descrição: Chave Dinamométrica

Marca: Mader Hand Tools

N. Ref. Especificação

61165 1/4" - 10 un

Quant. Caixa:

6

61167 1/2" - 1 un

1

61166 1/2" - 6 un

6



### CHAVE DE CAIXA LLAVES DE VASO SOCKET TOOLS SET



61146



5602225611464

**1/4"**  
**12un**



61147



5602225611471

**1/2"**  
**12un**

**Composição / Composición / Composition**

**Chaves**

10un - 4, 5, 6, 7, 8, 9, 10, 11, 12, 13 mm;

**Roquete**

1un - 72 Dentes

**Extensão**

1un - 100 mm

**Chaves**

10un - 10, 11, 12, 13, 14, 15, 17, 19, 22, 24 mm

**Roquete**

1un - 72 Dentes

**Extensão**

1un - 125 mm

N. Ref.	Descrição	Marca	Quant. Caixa
61146	CH CX-MHT-1/4" 12UN CRV	MADER HAND TOOLS	10
61147	CH CX-MHT-1/2" 12UN CRV	MADER HAND TOOLS	10

## CHAVE DE CAIXA LLAVES DE VASO SOCKET TOOLS SET

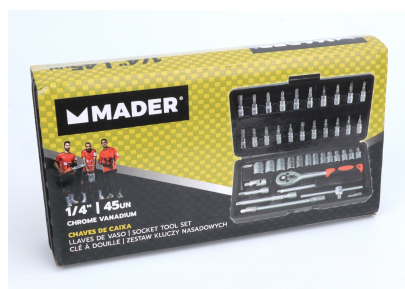

**1/4"**  
**45un**

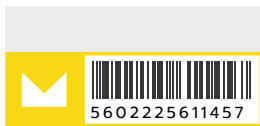

### Composição / Composición / Composition

#### Chaves Caixa | Llaves Vaso | Dr. Spline

13un - 1/4" - 4, 4.5, 5, 5.5, 6, 7, 8, 9, 10, 11, 12, 13, 14 mm

#### Extensões

2un - 1/4" - 50, 100 mm

1un - 1/4" - Flexível - 150 mm

#### Cabo Corrediço

1un - 1/4"

#### Roquete

1un - 1/4" - 45 Dentes

#### Cardan Universal

1un - 1/4"

#### Adaptador Bit

1un - 1/4"

#### Cabo Giratório

1un - 1/4"

#### Chaves Caixa com Bit

21un - 1/4" - SL4, SL5.5, SL7, PH1, PH2, PH3, PZ1, PZ2, PZ3, H3, H4, H5, H6, H7, H8, T10, T15, T20, T25, T30, T40

#### Chaves Sextavadas

3un - 15, 2, 2.5 mm

#### Mala Transporte

1un - Plástica

N. Ref.	Descrição	Marca	Quant. Caixa
61145	CH CX-MHT-1/4" 45UN CRV	MADER HAND TOOLS	2

## CHAVE DE CAIXA LLAVES DE VASO SOCKET TOOL SET

### CHROME VANADIUM



**1/4"**  
**46un**



#### Chaves Caixa /Llaves Vaso /Sockets:

4, 4.5, 5, 5.5, 6, 7, 8, 9, 10, 11, 12, 13, 14, mm

13 un - 1/4"

#### Chave Corrediça /Llave Corrediza /Sliding Bar:

1 un - 1/4"

#### Roquete /Carraca /Ratchet Handle

1 un - 1/4"

#### Extensão /Alargadera /Extension Bar

50, 100mm + Flexível /Flexible

3 un - 1/4"

#### Cardan Universal /Juntas Universales /Universal Joint

1 un - 1/4"

#### Bits /Puntas /Screwdriver Bits

⊖ 4, 5.5, 7mm

3 un

⊕ PH1, PH2, PH3

3 un

⊗ PZ1, PZ2, PZ3

3 un

● 3, 4, 5, 6, 7, 8mm

6 un

⊙ T10, T15, T20, T25, T30, T40

6 un

#### Adaptador /Adapter

1 un - 1/4" - 30mm

#### Porta Bit /Porta Puntas /Bit Driver

1 un - 1/4"

#### Chaves /Llave /Wrench

Hex:

4 un - 1,27 - 2,5mm

#### Mala /Caja /Case: - Plástico /Plastic

1 un

Descrição:	Chaves de Caixa
Marca:	Mader Hand Tools
N. Ref.	Especificação
51049	1/4" - 46 un

Quant. Caixa:	10
---------------	----



### CHAVE DE CAIXA LLAVES DE VASO SOCKET TOOL SET

CHROME VANADIUM **PROFISSIONAL**



**1/2"**  
19un



**Multi Lock**  
(todos os tipos de porcas)

Chaves Caixa /Llaves Vaso /Sockets:

8, 9, 10, 11, 12, 13, 14, 15, 16, 17, 18, 19, 20, 21, 22, 24, 27, 30, 32mm

19 un- 1/2"

Mala /Caja /Case: - Plástico

1 un

Descrição: Chaves de Caixa

Marca: Mader Hand Tools

N. Ref. Especificação  
59579 1/2" - 19 un

Quant. Caixa:  
10

### CHAVE DE CAIXA LLAVES DE VASO SOCKET TOOL SET

CHROME VANADIUM



**3/4"**  
20un + 1

Chaves Caixa /Llaves Vaso /Sockets:

19, 21, 22, 23, 24, 26, 27, 29, 30, 32, 35, 36, 38, 41, 46, 50mm

16 un-3/4"

Chave Corrediça /Llave Corrediza /Sliding Bar:

Roquete /Carraca /Ratchet Handle

1 un -3/4" - 495mm

Extensão /Alargadera /Extension Bar

100, 200, 400mm

2 un - 3/4" (100-200)

Cabo /Mango /Sliding Bar

1 un - 450mm

Mala /Caja /Case: - Plástico /Plastic

1 un



Descrição: Chaves de Caixa

Marca: Mader Hand Tools

N. Ref. Especificação  
61159 3/4" - 20 un

Quant. Caixa:  
1

**CHAVES CAIXA**  
**LLAVES DE VASO**  
**SOCKET TOOLS SET**

**Chrome-Vanadium**



**Chaves Caixa | Llaves Vaso | Dr. Spline: 10un - 1/4" - 4, 4.5, 5 5.5, 6, 7, 8, 9, 10, 11 mm;**  
**9un - 3/8" - 11, 12, 13, 14, 15, 16, 17, 18, 19 mm**  
**Cardan Universal | Dr. Universal Joint: 1un -3/8"**  
**Chave Caixa Velas | Llave para Bujías | Spark Plug Socket:**  
**1un - 3/8" x 16 mm**  
**Extensões | Prolongadores | Dr. Extension Bar:**  
**2un - 3/8" - 75, 150 mm**  
**Roquete | Carraca | Dr. Ratchet Handle: 1un - 72 Dentes | Dientes | Teeth - 3/8" Cabo Giratório | Mango Giratório | Spin Handle: 1un - 1/4"**  
**Bits | Pontas | Bits:**  
**24un - SL3, SL4, SL5, SL6, SL7, PH0, PH1, PH2, PH3, PZ0, PZ1, PZ2, PZ3, H2, H3, H4, H5, H6, T10, T15, T20, T25, T27, T30**  
**Adaptador | Adaptor: 1un - 3/8"(F)-1/4"(M) Adaptador Bit | Adaptador Punta | Bit Adaptor: 1un - 1/4"**  
**Iman Telescópico | Imán Telescópico | Pick Up Tools: 1un - 130-640 mm**  
**Mala Transporte | Caja | Suitcase: 1un -Plástica | Plástico | Plastic**

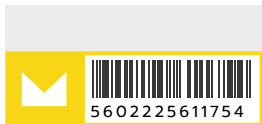

**1/4" - 3/8"**  
**52 un**

N. Ref.	Descrição	Marca	Quant. Caixa
61175	CH CX-MHT-JG 1/4"-3/8" 52PCS	MADER HAND TOOLS	4

**CHAVE DE CAIXA**  
**LLAVES DE VASO**  
**SOCKET TOOLS SET**



**Chaves Caixa / Llaves Vaso / Dr. Spline**

19un - 1/2" - (Sextavada) - 8, 9, 10, 11, 12, 13, 14, 15, 16, 17, 18, 19, 20, 21, 22, 24, 27, 30, 32 mm

6un - 1/2" (Estriada) - 10, 12, 14, 15, 17, 19 mm

**Chaves Caixa Velas / Llaves para Bujías / Spark Plug Socket**

2un - 1/2" - 16, 21 mm

**Extensões / Alargaderas / Extension Bar**

2un - 1/2" - 125, 250 mm

**Roquete / Carraca / Dr. Ratchet Handle 1un - 1/2" - 45 Dentes**

**Cardan Universal / Dr. Universal Joint 1un - 1/2"**

**Adaptador 3 Vias / Adaptador 3 Vías / 3 Way Adaptor**

1un

**Mala Transporte / Caja / Carrynig Case**

1un - Plástica / Plástico / Plastic



**1/2"**  
**32un**



N. Ref.	Descrição	Marca	Quant. Caixa
61144	CH CX-MHT-1/2" 32PCS CRV	MADER HAND TOOLS	12

### CHAVE DE CAIXA LLAVES DE VASO SOCKET TOOLS SET

- Chaves Caixa / Llaves Vaso / Dr. Spline**  
17un - 1/2" - 10, 11, 12, 13, 14, 15, 16, 17, 18, 19, 20, 21, 22, 24, 27, 30, 32 mm  
13un - 1/4" - 4, 4.5, 5, 5.5, 6, 7, 8, 9, 10, 11, 12, 13, 14 mm
- Chaves Caixa Longas / Llaves Vaso Largas / Dr. Deep Spline**  
5un - 1/2" - 14, 15, 17, 19, 22 mm  
8un - 1/4" - 6, 7, 8, 9, 10, 11, 12, 13 mm
- Chaves Caixa - Torx / Llaves Vaso - Torx / Dr. Spline - Torx**  
8un - 1/2" - E10, E11, E12, E14, E16, E18, E20, E24  
5un - 1/4" - E4, E5, E6, E7, E8
- Cardan Universal / Dr. Universal Joint**  
2un - 1/2" - 1/4"
- Chaves Caixa Velas / Llaves para Bujias / Spark Plug Socket**  
2un - 1/2" x 16, 21 mm
- Extensões / Prolongadores / Dr. Extension Bar**  
2un - 1/2" - 125, 250 mm  
1un - 1/4" - 100 mm
- Cabo Corrediço / Mango Corredizo / Sliding T Bar**  
1un - 1/4"
- Roquete / Carraca / Dr. Ratchet Handle**  
2un - 45 Dentes | Dientes | Teeth - 1/2" - 1/4"
- Chaves Caixa com Bit / Llaves Vaso con Punta / Dr. Bit Socket**  
18un - 1/4" - SL4, SL5.5, SL6.5, PH1, PH2, PZ1, PZ2, H3, H4, H5, H6, T8, T10, T15, T20, T25, T27, T30
- Bits / Puntas**  
17un - SL8, SL10, SL12, PH3, PH4, PZ3, PZ4, H7, H8, H10, H12, H14, T40, T45, T50, T55, T60
- Cabo Giratório / Mango Giratório / Spin Handle**  
1un - 1/4"
- Adaptador Bit / Adaptador Punta / Bit Adaptor**  
1un - 1/2"
- Adaptador 3 Vias / Adaptador 3 Vias / 3 Way Adaptor**  
1un
- Chaves Umbrako Sextavadas / Llaves Hexagonales / Hex Key Wrench**  
4un - 1.27, 1.5, 2, 2.5 mm
- Mala Transporte / Caja / Carrying Case**  
1un - Plástica/Plástico/Plastic



61142



5602225611426

**1/4"-1/2"**  
**108un**

N. Ref.	Descrição	Marca	Quant. Caixa
61142	CH CX-MHT-1/4"-1/2" 108UN CRV	MADER HAND TOOLS	3

### CHAVE DE CAIXA LLAVES DE VASO SOCKET TOOLS SET

#### Chaves Caixa / Llaves Vaso / Dr. Spline

14un - 1/2" - 13, 14, 15, 16, 17, 18, 19, 20, 21, 22, 24, 27, 30, 32 mm

10un - 3/8" - 10, 11, 12, 13, 14, 15, 16, 17, 18, 19 mm

13un - 1/4" - 4, 4.5, 5, 5.5, 6, 7, 8, 9, 10, 11, 12, 13, 14 mm

#### Chaves Caixa Longas / Llaves Vaso Largas / Dr. Deep Spline

5un - 1/2" - 16, 17, 18, 19, 22 mm

6un - 3/8" - 10, 11, 12, 13, 14, 15 mm

7un - 1/4" - 4, 5, 6, 7, 8, 9, 10 mm

#### Chaves Caixa - Torx / Llaves Vaso - Torx / Dr. Spline - Torx

3un - 1/2" - E20, E22, E24

6un - 3/8" - E10, E11, E12, E14, E16, E18

5un - 1/4" - E4, E5, E6, E7, E8

#### Cardan Universal / Dr. Universal Joint

3un - 1/2" - 3/8" - 1/4"

#### Chaves Caixa Velas / Llaves para Bujías / Spark Plug Socket

2un - 1/2" - 16, 21 mm

1un - 3/8" - 21 mm

#### Extensões / Prolongadores / Dr. Extension Bar

2un - 1/2" - 125, 250 mm

1un - 3/8" - 150 mm

2un - 1/4" - 50, 100 mm

#### Cabo Corrediço / Mango Corredizo / Sliding T Bar

1un - 1/4"

#### Roquete / Carraca / Dr. Ratchet Handle

3un - 72 Dentes - 1/2" - 3/8" - 1/4"

#### Chaves Caixa com Bit / Llaves Vaso con Punta / Dr. Bit Socket

2un - 1/2" - T55, T60

30un - 1/4" - SL4, SL5, SL5.5, SL6, SL7, PH1, PH2, PH3, PZ1, PZ2,

PZ3, H2, H3, H4, H5, H6, H7, H8, H10, TX8, TX10, TX15, TX20,

TX25, TX27, TX30, TX40, M4, M5, M6

#### Bits / Puntas

30un - (8mm) - SL6, SL6.5, SL8, PH3, PH4, PZ3, PZ4, H5, H6, H8,

H10, T25, T27, T30, T35, T40, T45, T50, T55, TX27, TX30, TX35,

TX40, TX45, TX50, TX55, M5, M6, M8, M10

50un - (6.35mm) - SL3, SL4, SL5, SL6, SL7, PH0, PH1, PH2, PH3,

PZ0, PZ1, PZ2, PZ3, H1.5, H2, H2.5, H3, H4, H5, H5.5, H6, T8, T9,

T10, T15, T20, T25, T27, T30, T40; TX8, TX10, TX15, TX20, TX25,

TX27, TX30, TX40, M5, M6, SQ0, SQ1, SQ2, SQ3, SP4, SP6, SP8,

TW1, TW2, TW3

#### Adaptador Bit / Adaptador Punta / Bit Adaptor

3un - 1/2" - 3/8" - 1/4"

#### Cabo Giratório / Mango Giratório / Spin Handle

1un - 1/4"

#### Chave Parafusos / Destornillador / Screwdriver

1un - 1/4"

#### Adaptador / Adaptor

1un - 3/8"(F)-1/2"(M)

#### Chaves Boca-Luneta / Llaves Fijas Combinadas / Combination

#### Wrench

12un - 8, 9, 10, 11, 12, 13, 14, 15, 16, 17, 18, 19 mm

#### Chaves Sextavadas / Llaves Hexagonales / Hex Key

4un - 1.27, 1.5, 2, 2.5

#### Mala Transporte / Caja / Carryng Case

1un - Plástica / Plástico / Plastic



61143



5602225611433

**1/4"-3/8"-1/2"**  
**218un**

Ref.	Descrição	Marca	Quant. Caixa
61143	CH CX-MHT-1/4"-3/8"-1/2" 218UN	MADER HAND TOOLS	2

## MALA DE FERRAMENTA CAJA DE HERRAMIENTA HAND TOOL SET



51306



**78un**  
**3/8"**

### » » » CHROME VANADIUM « « «



#### Ferramenta /Herramienta /Tool

##### Chaves Caixa /Llaves Vaso /Sockets:

8, 9, 10, 11, 12, 13, 14, 15, 16, 17, 18, 19, 21, 22mm 14 un - 3/8"

Roquete /Carraca /Ratchet Handle 1 un - 3/8"

Extensão /Alargadera /Extension Bar  
75 mm 1 un - 3/8"

##### Bits /Puntas / Screwdriver Bit

⊖ 3, 4, 5, 5.5, 6 mm 5 un

⊕ PH0, PH1, PH2(x2), PH3 5 un

⊗ Hex: 2, 3, 4, 5, 6 mm 5 un

⦿ S0, S1, S2(X2), S3 5 un

⦿ T10, T15, T20, T25, T30 5 un

⦿ PZ0, PZ1, PZ2(x2), PZ3 5 un

Cabo /Mango /Handle 1 un - 1/4"

##### Chaves /Destornillador /Screwdrivers

⊖ 6x100, 6x150 mm 2 un

⊕ PH2x100mm; PH2x150mm 2 un

##### Precisão /Precisión /Precision

⊕ PH00-S15, PH0-S25 2 un

⦿ T4-H2, T7-H15 2 un

Cabo /Mango /Handle 1 un

##### Chaves /Llave /Wrench

Boca-Luneta /Fijas Combinadas /Combination:  
8, 10, 11, 12, 13, 14, 15, 17 mm 8 un

Sextavadas /Hex:  
15, 2, 25, 3, 4, 5, 6, 8, 10 mm 9 un

##### Alicate /Plier

Universal /Combination 1 un - 7"

Pontas /Boca Redonda /Long Nose : 1 un - 6"

Corte Lateral /Corte Diagonal /Diagonal : 1 un - 6"

Fita Métrica /Flexómetro /Measuring Tape: 1 un - 3 m

Martelo Carpinteiro /Martillo Orejas /Claw Hammer 1 un - 300 gr

Mala /Caja /Case: - Plástico /Plastic 1 un

Descrição: Mala de Ferramenta

Marca: Mader Hand Tools

N. Ref. Especificação

51306 Sortida - 78 un

Quant. Caixa:

3

**MALA DE FERRAMENTA**  
CAJA DE HERRAMIENTA  
HAND TOOL SET

**METAL**



**5** Divisórias  
Particiones  
Partitions



» » » **CHROME VANADIUM** « « «

<b>Ferramenta /Herramienta /Tool</b>	
Chaves Caixa /Llaves Vaso /Sockets:	11 un - 1/4"
	14 un - 1/2"
União /Unión /Dr. Socket Plug: - 16, 21mm	2 un - 1/2"
Roquete /Carraca /Ratchet Handle	1 un - 1/4"
	1 un - 1/2"
Extensão /Alargadera /Extension Bar	
75mm	1 un - 1/4"
125mm, 250mm (3 Entradas /Way adapt)	2 un - 1/2"
Bits /Puntas	
⊖ 4, 5,5, 7mm	3 un - 1/4" - 25mm
⊕ PH1, PH2, Ph3	3 un - 1/4" - 25mm
● 3, 4, 5, 6, 8mm	5 un - 1/4" - 25mm
Chave /Llave /Screwdriver	1 un
Adaptador /Adaptor	1 un - 1/4"
Junta Universal /Universal Joint	1 un - 1/2"
Chave /Destornillador /Screwdrivers	
⊖ 5x75; 6x100; 8x150mm;	3 un
⊕ PH1 x75mm; PH2 x100mm	2 un
● 15, 2, 2,5, 3, 4, 5, 6, 7, 8, 10mm	10 un
Chaves /Llaves /Wrench	
Boca-Luneta /Spanners:	
6, 7, 8, 9, 10, 11, 12, 13, 14, 15, 16, 17mm	12 un
Alicate /Plier	
Pontas /Boca Redonda /Long Nose :	1 un - 150mm
Corte Lateral /Corte Diagonal /Diagonal :	1 un - 150mm
Bomba d'Água /Pico Loro /Water Pump :	1 un - 250mm
Fixação /Mordaza /Locking :	1 un - 250mm
Fita Métrica /Flexómetro /Measuring Tape:	1 un - 3 m
X-Ato /Cortador /Knife:	1 un - 18mm
Lâminas /Hojas /Blades	10 un
Mala /Caja /Case: - Plástico /Plastic	1 un - 470x200x200mm



**+**  
**SERROTE**  
**SIERRA**  
**HACKSAW:**  
**300mm**

**93un**  
**1/4" - 1/2"**



**+**  
**MARTELO BOLA**  
**MARTILLO BOLA**  
**BALL HAMMER**  
**16oz**



Descrição: Mala Ferramenta - Metal

Marca: Mader Hand Tools

N. Ref. Especificação Quant. Caixa:  
61158 Sortida - 93 un - 5 Div. c/ Martelo 1

### MALA DE FERRAMENTA CAJA DE HERRAMIENTA HAND TOOL SET



59603



**123un**  
1/4" - 1/2"



516022251596037

## » » » CHROME VANADIUM « « «

### Ferramenta /Herramienta /Tool

#### Chaves Caixa /Llaves Vaso /Sockets:

10, 13, 14, 16, 17, 18, 19, 20, 22, 24, 27, 30, 32mm	13 un - 1/2"
4, 4.5, 5, 5.5, 6, 7, 8, 9, 10, 11, 12, 13, 14mm	13 un - 1/4"
Velas /Bujías /Spark Plug	2 un - 1/2" - 16, 21 mm

#### Chave Corrediça /Llave Corrediza /Sliding Bar:

	1 un - 1/2"
	1 un - 1/4"

#### Roquete /Carraca /Ratchet Handle

	1 un - 1/2" - 72 D
	1 un - 1/4" - 72 D

#### Extensão /Alargadera /Extension Bar

	1 un - 1/2" - 5"
	2 un - 1/4" - 2", 4"

#### Adaptador Universal /Universal Adaptor

	1 un - 1/2"
	1 un - 1/4"

#### Bits /Puntas / Screwdriver Bit

	31 un
--	-------

#### Encaixe /Encaje / Coupler

	1 un - 1/4"
--	-------------

#### Encaixe /Encaje / Holder

	1 un - 30 mm
--	--------------

#### Chaves /Destornillador /Screwdrivers

Plana-flat: 5x75, 6x100 mm	2 un
Phillips: PH1x75mm; PH2x100mm	2 un
Hex:	9 un

3 em /en /in 1	4 un
----------------	------

#### com Roquete /con Carraca / with Ratchet

	1 un
--	------

#### Chaves /Llave /Wrench

Boca-Luneta /Fijas Combinadas /Combination:	9 un
8, 10, 11, 12, 13, 15, 17, 19, 22mm	
Crescente /Graduable /Adjustable	1 un - 10"

	1 un - 10"
--	------------

#### Alicate /Plier

Universal /Combination	1 un - 7"
Pontas /Boca Redonda /Long Nose :	1 un - 8"
Corte Lateral /Corte Diagonal /Diagonal :	1 un - 6"
Descarnar /Ojetero /Stripping:	1 un - 9"
Bomba d'Água /Pico Loro /Water Pump:	1 un - 10"
Freios /Arandelas /Circlip	4 un

	1 un - 6"
--	-----------

	3 un
--	------

	1 un
--	------

	1 un - 5 m
--	------------

	1 un - 12" - Alumínio
--	-----------------------

	1 un - 12 Oz
--	--------------

	1 un - 110 - 250 V
--	--------------------

	6 un
--	------

	1 un
--	------

	1 un
--	------

	1 un
--	------

	1 un
--	------

	1 un
--	------

	1 un
--	------

	1 un
--	------

	1 un
--	------

	1 un
--	------

	1 un
--	------

	1 un
--	------

	1 un
--	------

	1 un
--	------

	1 un
--	------

	1 un
--	------

	1 un
--	------

	1 un
--	------

	1 un
--	------



**4** Divisórias  
Particiones  
Partitions

Descrição: Mala de Ferramenta

Marca: Mader Hand Tools

N. Ref. Especificação Quant. Caixa:

59603 Sortida - 123 un - 4 Divisórias 1



## CARRO FERRAMENTA CARRO DE HERRAMIENTA TOOL CART



**Dimensões /Dimensiones /Size: - 793x785x480mm**  
**6 un. - Gaveta /Cajón /Drawer**  
**1 un. - Porta /Porta /Door**  
**156 un. - Ferramenta /Herramienta /Tool**



Descrição: **Carro Ferramenta**  
 Marca: **Mader Hand Tools**  
 N. Ref. Especificação  
 51312 156 un - 7 Divisórias

Quant. Caixa:  
1

## METAL



## PROFISSIONAL



**156un**  
1/4" - 3/8" - 1/2"



**Gavetas**  
c/ deslizamento fácil  
e fecho de segurança

**TRAVÃO**  
**FRENO**  
**BRAKE**



**7** Divisórias  
Particiones  
Partitions

**Cajones**  
c/ rodamientos fácil  
deslizamiento  
y cerradura de seguridad

## » » » CHROME VANADIUM « « «

### Chaves Caixa /Llaves Vaso /Sockets:

4, 4.5, 5, 5.5, 6, 7, 8, 9, 10, 11, 12, 13, 14mm	13 un - 1/4"
8, 9, 10, 11, 12, 13, 14, 15, 16, 17, 18, 19, 20, 21, 22, 24mm	16 un - 3/8"
10, 11, 12, 13, 14, 15, 16, 17, 18, 19, 21, 22, 23, 24, 27, 30, 32mm	17 un - 1/2"
Longa /Larga /Long	
4, 5, 6, 7, 8, 9, 10, 11, 12mm	9 un - 1/4"
Chave Corrediça /Llave Corrediza /Sliding Bar:	3 un - 1/4" - 3/8" - 1/2"
Roquete /Carraca /Ratchet Handle	3 un - 1/4" - 3/8" - 1/2"
Extensão /Alargadera /Extension Bar	
50, 100mm	2 un - 1/4"
75, 150mm	2 un - 3/8"
125, 250mm	2 un - 1/2"
Cardan Universal /Juntas Universales /Universal Joint	3 un - 1/4" - 3/8" - 1/2"
Cabo /Mango /Handle:	1 un - 1/4"

### Bits /Puntas /Screwdriver Bit

Chave Caixa /Llave Vaso /Socket	
⊖ SL3, SL4, SL5, SL6 ⊕ PH1, PH2, PH3, ⊗ PZ1, PZ2, PZ3	21 un - 1/4"
⊙ H3, H6, H7, H8 ⊕ T8, T10, T15, T20, T25, T30, T40	

### Chaves Parafusos /Destornillador /Screwdrivers

⊖ 6x38, 3x75, 4x100, 5x100, 6x150, 8x200mm	6 un
⊕ PH2x38, PH0x75, PH1x100, PH2x100, PH2x150, PH3x1200	6 un
VDE ⊖ 3x75, 4x100, 5x125	3 un
VDE ⊕ PH0x75, PH1x100, PH2x100	3 un
Precisão /Precisión /Precision	
1, 2, 3	3 un
PH0, PH1, PH2	3 un

### Chaves /Llave /Wrench

Torx T9, T10, T15, T20, T25, T27, T30, T40	8 un
Hex 15, 2, 2.5, 3, 4, 5, 6, 8, 10mm	9 un
Boca-Luneta, Combinadas, Combination	
fixas /fijas /fixed	
8, 9, 10, 11, 12, 13, 14, 15, 16, 17, 19, 20, 22mm	13 un

### Alicate /Plier

Universal /Combination	1 un - 8"
Pontas /Boca Redonda /Long Nose :	1 un - 8"
Corte Lateral /Corte Diagonal /Diagonal :	1 un - 7"
Bomba d'Água /Pico Loro /Water Pump:	1 un - 10"
Fixação /Mordaza /Locking	1 un - 10"
Freios /Arandelas /Circlip	4 un - 6"
Mala /Caja /Case: - Plástico /Plastic	1 un

## CARRO FERRAMENTA CARRO DE HERRAMIENTA TOOL CART



**Dimensões / Dimensiones / Size:** - 793x785x480mm  
**6 un. - Gaveta / Cajón / Drawer**  
**1 un. - Porta / Porta / Door**  
**156 un. - Ferramenta / Herramienta / Tool**



### Chave Combinada c/ Roquete-Carraca»»



## METAL



## PROFISSIONAL



**156un**  
1/4" - 3/8" - 1/2"



**Gavetas**  
c/ deslizamento fácil  
e fecho de segurança

**TRAVÃO**  
**FRENO**  
**BRAKE**



**7** Divisórias  
Particiones  
Partitions

**Cajones**  
c/ rodamientos fácil  
deslizamiento  
y cerradura de seguridad

## » » » CHROME VANADIUM « « «

### Chaves Caixa /Llaves Vaso /Sockets:

4, 4.5, 5, 5.5, 6, 7, 8, 9, 10, 11, 12, 13, 14mm	13 un - 1/4"
8, 9, 10, 11, 12, 13, 14, 15, 16, 17, 18, 19, 20, 21, 22, 24mm	16 un - 3/8"
10, 11, 12, 13, 14, 15, 16, 17, 18, 19, 21, 22, 23, 24, 27, 30, 32mm	17 un - 1/2"
Longa /Larga /Long	
4, 5, 6, 7, 8, 9, 10, 11, 12mm	9 un - 1/4"
Chave Corrediça /Llave Corrediza /Sliding Bar:	3 un - 1/4" - 3/8" - 1/2"
Roquete /Carraca /Ratchet Handle	3 un - 1/4" - 3/8" - 1/2"
Extensão /Alargadera /Extension Bar	
50, 100mm	2 un - 1/4"
75, 150mm	2 un - 3/8"
125, 250mm	2 un - 1/2"
Cardan Universal /Juntas Universales /Universal Joint	3 un - 1/4" - 3/8" - 1/2"
Cabo /Mango /Handle:	1 un - 1/4"

### Bits /Puntas /Screwdriver Bit

Chave Caixa /Llave Vaso /Socket	
⊖ SL3, SL4, SL5, SL6 ⊕ PH1, PH2, PH3, ⊗ PZ1, PZ2, PZ3	21 un - 1/4"
⊙ H3, H6, H7, H8 ⊕ T8, T10, T15, T20, T25, T30, T40	

### Chaves Parafusos /Destornillador /Screwdrivers

⊖ 6x38, 3x75, 4x100, 5x100, 6x150, 8x200mm	6 un
⊕ PH2x38, PH0x75, PH1x100, PH2x100, PH2x150, PH3x1200	6 un
VDE ⊖ 3x75, 4x100, 5x125	3 un
VDE ⊕ PH0x75, PH1x100, PH2x100	3 un
Precisão /Precisión /Precision	
1, 2, 3	3 un
PH0, PH1, PH2	3 un

### Chaves /Llave /Wrench

Torx T9, T10, T15, T20, T25, T27, T30, T40	8 un
Hex 15, 2, 2.5, 3, 4, 5, 6, 8, 10mm	9 un
Boca-Luneta, Fijas Combinadas, Combination c/ Roquete /con Carraca /Ratchet	
8, 9, 10, 11, 12, 13, 14, 15, 16, 17, 19, 20, 22mm	13 un

### Alicate /Plier

Universal /Combination	1 un - 8"
Pontas /Boca Redonda /Long Nose :	1 un - 8"
Corte Lateral /Corte Diagonal /Diagonal :	1 un - 7"
Bomba d'Água /Pico Loro /Water Pump:	1 un - 10"
Fixação /Mordaza /Locking	1 un - 10"
Freios /Arandelas /Circlip	4 un - 6"
Mala /Caja /Case: - Plástico /Plastic	1 un

Descrição: Carro Ferramenta  
 Marca: Mader Hand Tools  
 N. Ref. 51311 Especificação 156 un - 7 Divisórias  
 Quant. Caixa: 1

**TABULEIRO » CARRO FERRAMENTA**  
**BANDEJA » CARRO DE HERRAMIENTA**  
**TRAY » TOOL CART**

**»»»» CHROME VANADIUM ««««**  
**PROFISSIONAL**

**CHAVES BOCA-LUNETETA**  
 LLAVES COMBINADAS  
 COMBINATION WRENCH

**ROQUETE**  
 CARRACA  
 RATCHET

**13 un**  
 8, 9, 10, 11, 12, 13, 14, 15, 16, 17, 19, 21, 22mm



**Nº 1**  
 13un

**CHAVES**  
 LLAVES  
 WRENCH

**9 un - 1/4" » Caixa Longa /Vaso Larga /Long Socket**  
 4, 5, 6, 7, 8, 9, 10, 11, 12mm  
**23 un - 1/4" » Caixa /Vaso /Socket + Bit**  
 SL3-SL4-SL5-SL6 || PH1-PH2-PH3-PZ1-PZ2-PZ3-H3  
 H4-H5-H6-H7-H8 || T8-T10-T15-T20-T25-T30-T40  
**9 un - Sextavada /Hexagonale /Hex Key**  
 1,5, 2, 2,5, 3, 4, 5, 6, 8, 10mm



**Nº 2**  
 41un

**ALICATE**  
 PLIER

**1 un - 10" » Fixação /Mordaza /Locking**  
**1 un - 10" » Bomba d'Água /Pico Loro /Water Pump**



**Nº 3**  
 2un

**ALICATE**  
 PLIER

**1 un - 8" » Universal /Combination**  
**1 un - 8" » Pontas /Boca Redonda /Long Nose**  
**1 un - 7" » Corte Lateral /Corte Diagonal /Diagonal**



**Nº 4**  
 3un

**2 un - 6" » Ponta Direita /Boca Semi-Redonda /Long Nose**  
 Interior /Internal || Exterior /External  
**2 un - 6" » Ponta Curva /Boca Curvada /Bent Nose**  
 Interior /Internal || Exterior /External

**ALICATE FREIOS**  
 ALICATE ARANDELAS  
 SNAP RING PLIE



**Nº 5**  
 4un

Descrição: **Tabuleiro » Carro Ferramenta**

Marca: **Mader Hand Tools**

N. Ref.	Especificação	Quant. Caixa:
51315	Nº 1 - 13 un	1/5
51316	Nº 2 - 41 un	1/10
51317	Nº 3 - 2 un	1/10
51318	Nº 4 - 3 un	1/10
51319	Nº 5 - 4 un	1/10

**TABULEIRO » CARRO FERRAMENTA**  
**BANDEJA » CARRO DE HERRAMIENTA**  
**TRAY » TOOL CART**

**»»»» CHROME VANADIUM ««««**  
**PROFISSIONAL**

**CHAVES PARAFUSO**  
**DESTORNILLADORES**  
**SCREWDRIVER**

**6 un**  
 PH0x75, PH1x100, PH2x38, PH2X100, PH2x150, Ph3x200



**Nº 6**  
 6un

**CHAVES PARAFUSO**  
**DESTORNILLADORES**  
**SCREWDRIVER**

**6 un**  
 6x38, 3x75, 4x100, 5X100, 6x150, 8x200 mm



**Nº 7**  
 6un

**CHAVES PARAFUSO**  
**DESTORNILLADORES**  
**SCREWDRIVER**

**6 un** - VDE  
 PH0x75, PH1x100, PH2X100 || 3x75, 4x100, 5X100mm  
**6 un** - Precisão /Precisión /Precision  
 PH0, PH1, PH2 || 1, 2, 3mm  
**8 un** - Torx  
 T9, T10, T15, T20, T25, T27, T30, T40



**Nº 8**  
 20un

**CHAVES CAIXA**  
**LLAVES VASO**  
**SOCKETS**

**17 un - 1/2"** » 10, 11, 12, 13, 14, 15, 16, 17, 18, 19, 20, 21, 22, 23, 24, 27, 30, 32mm  
**1 un - 1/2"** » Chave Corrediça /Llave Corrediza /Sliding Bar T  
**1 un - 1/2"** » Roquete /Carraca /Ractchet Handle  
**2 un - 1/2"** » Extensão /Alargadera /Extension Bar 125, 250mm  
**1 un - 1/2"** » Cardan Universal /Juntas Universales /Universal Joint



**Nº 9**  
 22un

**CHAVES CAIXA**  
**LLAVES VASO**  
**SOCKETS**

**13 un - 1/4"** » 4, 4.5, 5, 5.5, 6, 7, 8, 9, 10, 11, 12, 13, 14mm  
**1 un - 1/4"** » Chave Corrediça /Llave Corrediza /Sliding Bar T  
**1 un - 1/4"** » Roquete /Carraca /Ractchet Handle  
**2 un - 1/4"** » Extensão /Alargadera /Extension Bar 50, 100mm  
**1 un - 1/4"** » Cardan Universal /Juntas Universales /Universal Joint  
**1 un - 1/4"** » Cabo /Mango /Handle



**Nº 10**  
 19un

Descrição: **Tabuleiro » Carro Ferramenta**

Marca: **Mader Hand Tools**

N. Ref.	Especificação	Quant. Caixa:
51320	Nº 6 - 6 un	1/10
51321	Nº 7 - 6 un	1/10
51322	Nº 8 - 20 un	1/10
51323	Nº 9 - 22 un	1/10
51324	Nº 10 - 19 un	1/10

**PONTA MAGNÉTICA / PUNTA MÁGNÉTICA**

### VENTOSA VENTOSA SUCTION PAD

**Estrutura em plástico resistente com ventosas;**  
**De fácil utilização**  
**Apertar os clips de ambas as pegas para fazer sucção;**  
**Ideal para tratar amolgadelas ou elevar artigos lisos;**

Estructura en plástico resistente con ventosas;  
De fácil uso  
Apretar las grapas de ambas las manijas p/ hacer succión;  
Ideal para tratar abolladuras o izar artículos llanos;

Durable plastic body with rubber suction cup;  
Easy to use  
Tighten and clip the two handles to create suction;  
Great for pulling dents or lifting flat items;



**50Kg**  
ref:125 - 120mm



**DUPLA  
DOBLE  
DOUBLE**



**70Kg**  
ref:125 - 120mm



**TRIPLA  
TRIPLE**



**100Kg**  
ref:125 - 125mm

Descrição: **Ventosa**

Marca: **Mader Hand Tools**

N. Ref.	Especificação	Quant.	Caixa:
61011	Simples - 50 Kg - 120mm	60	
61012	Dupla - 70 Kg - 120mm	24	
61013	Dupla - 100 Kg - 125mm	24	

### BANDEJA DE BORRACHA BANDEJA DE GOMA RUBBER TOOL TRAY

**100% FLEXÍVEL**  
**FLEXIBLE**

**ADERENTE**  
**ADHERENTE**  
**NON-SLIP**

**270x134x25mm**



Descrição: **Bandeja Borracha**

Marca: **Mader Hand Tools**

N. Ref.	Especificação	Quant.	Caixa:
61218	27 x 13,4 cm	20	
61219	27 x 21,6 cm	20	

**270x216x25mm**



### O'RINGS

#### JUNTAS DE GOMA

#### O-RINGS

- |                          |                          |                          |
|--------------------------|--------------------------|--------------------------|
| <b>20un</b> -3x1.5mm;    | <b>23un</b> -7x1.5mm;    | <b>23un</b> -10x1.5mm    |
| <b>23un</b> -13x1.5mm;   |                          |                          |
| <b>20un</b> -4.4x2.0mm;  | <b>18un</b> -5x2.0mm;    |                          |
| <b>14un</b> -10x2.5mm;   | <b>13un</b> -11x2.5mm;   | <b>14un</b> -13x2.5mm;   |
| <b>13un</b> -14x2.5mm;   | <b>14un</b> -16x2.5mm;   | <b>14un</b> -18x2.5mm;   |
| <b>13un</b> -19x2.5mm;   | <b>14un</b> -21x2.5mm;   | <b>13un</b> -22x2.5mm;   |
| <b>10un</b> -18x3.5mm;   | <b>10un</b> -20x3.5mm;   | <b>10un</b> -22x3.5mm;   |
| <b>10un</b> -23.5x3.5mm; | <b>10un</b> -25x3.5mm;   | <b>10un</b> -26.5x3.5mm; |
| <b>10un</b> -28x3.5mm;   | <b>10un</b> -30x3.5mm;   | <b>10un</b> -31x3.5mm;   |
| <b>10un</b> -33x3.5mm;   | <b>10un</b> -34.5x3.5mm; | <b>10un</b> -36x3.5mm;   |
| <b>10un</b> -38x3.5mm;   | <b>10un</b> -41x3.5mm;   | <b>10un</b> -44x3.5mm;   |
| <b>10un</b> -47x3.5mm;   | <b>10un</b> -50x3.5mm;   |                          |

Descrição: O' rings

Marca: Mader Hand Tools

N. Ref. Especificação  
61550 419 pç

Quant. Caixa:  
6



419un



### MULTÍMETRO

#### MULTIMETRO

#### MULTIMETER

### DIGITAL

Tensão DC /Tensión DC /DC Voltage

Tensão AC /Tensión AC /AC Voltage

Corrente DC /Corriente DC /DC Current

Teste de Transistores /Transistor Test

Medidor de Resistencia /Ohm

Teste de Díodos /Teste de Diodos /Diode Test



Tensão DC /Tensión DC /DC Voltage

Tensão AC /Tensión AC /AC Voltage

Corrente DC /Corriente DC /DC Current

Teste de Transistores /Transistor Test

Medidor de Resistencia /Ohm

Teste de Díodos /Teste de Diodos /Diode Test

Memorização de Dados /Memorización de Datos /Data Hold



Descrição: Multímetro

Marca: Mader Hand Tools

N. Ref. Especificação

61006 830B - Digital

61007 830L - Digital

Quant. Caixa:

10/40

100

### TORNO DE BANCADA TORNILLO DE BANCO BENCH VICE



**FIXO**  
FIJO  
FIXED



**1Ton**



**100mm**  
4"

**3Ton**



**150mm**  
6"

Descrição: Torno de Bancada - Fixo

Marca: Mader Hand Tools

N. Ref.	Especificação	Quant.	Caixa:
23148	4" - 100mm - 1 Ton	1	
23149	6" - 150mm - 3 Ton	1	

### BATENTE e BASE ROTATIVA TOPE y BASE GIRATORIA ANVIL and SWIVEL BASE

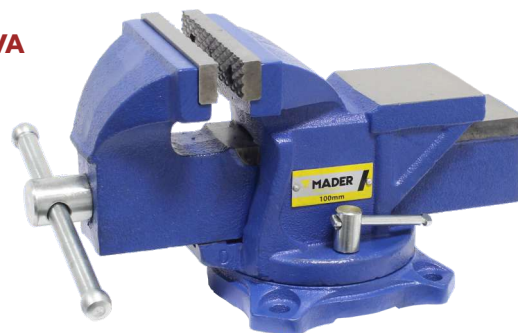

Descrição: Torno de Bancada - Base Rotativa

Marca: Mader Hand Tools

N. Ref.	Especificação	Quant.	Caixa:
23152	5" - 125mm	2	
23153	6" - 150mm	2	



**125mm**  
5"



**150mm**  
6"

- **Base Giratória 360° c/ Porcas de Bloqueio Duplo**  
Base giratória de 360° con tuercas de bloqueo dobles  
360° Swivel Base with Dual Lock Down Nuts;
- **Base de grampa de aço antiderrapante substituível**  
Almohadillas de mordaza de acero antideslizantes  
reemplazable /Replaceable Non-Slip Steel Jaw Pads;
- **Grampa de tubo serrilhado**  
/Mordazas dentadas para tubos /Serrated Pipe Jaws;
- **Punho em T deslizante cromado** /Mango en T desli-  
zante cromado /Chrome Plated Sliding T-Bar Handle;
- **Abertura da grampa: 126mm**  
/Abertura de Mordaza /Jaw Opening
- **Profundidade** /Profundidade /Throat Depth: **70mm**
- **Tamanho da bigorna: 80x64mm**  
Tamaño del Yunque /Anvil Size

### TORNO MULTIFUNÇÕES TORNILLO MULTIFUNCIÓN MULTI-PURPOSE VICE

### BASE ROTATIVA BASE GIRATORIA SWIVEL BASE

**125mm**      5"



Descrição: Torno de Bancada

Marca: Mader Hand Tools

N. Ref.	Especificação	Quant.	Caixa:
23154	Multifunções - 5" - 125mm	1	



### MARTELO DE BOLA MARTILLO DE BOLA BALL PEIN HAMMER

**CABO FIBRA VIDRO / TPR**  
MANGO FIBRA DE VIDRIO  
FIBERGLASS HANDLE



**16oz** 29mm  
454gr

**CABO DE MADEIRA**  
MANGO EN MADERA  
WOODEN HANDLE



**24oz** 32mm  
680gr



**32oz** 35mm  
907gr



**16oz** 27mm  
454gr



**REFORÇADO / REFORZADO / REINFORCED**

Descrição: Martelo de Bola		Quant. Caixa:	
Marca: Mader Hand Tools	N. Ref. Especificação		
	61026 C. Madeira - 16 oz	6/36	
	61027 C. Madeira - 24 oz	6/24	
	61028 C. Madeira - 32 oz	6/24	
	61025 C. Fibra TPR - 16 oz	6/60	
	61428 C. Fibra TPR - 24 oz - Reforç	6/24	
	61429 C. Fibra TPR - 48 oz - Reforç	6/24	



**24oz** 35mm  
680gr



**48oz** 42mm  
1360gr

### MAÇO DE BORRACHA MAZA GOMA RUBBER Mallet

**PRETO**  
NEGRO  
BLACK

**CABO DE MADEIRA**  
MANGO EN MADERA  
WOODEN HANDLE

**BRANCO**  
BLANCO  
WHITE

**CABO DE MADEIRA**  
MANGO EN MADERA  
WOODEN HANDLE



**12oz** 50mm  
340gr



**8oz** 48mm  
227gr



**12oz** 50mm  
340gr

**CABO FIBRA VIDRO / TPR**  
MANGO FIBRA DE VIDRIO  
FIBERGLASS HANDLE



**BRANCO**  
BLANCO  
WHITE

Descrição: Maço de Borracha		Quant. Caixa:	
Marca: Mader Hand Tools	N. Ref. Especificação		
	61058 Preto - 8 oz - C. Madeira	6/36	
	61059 Preto - 12 oz - C. Madeira	6/36	
	61060 Branco - 12 oz - C. Madeira	6/36	
	61043 Branco - 16 oz - C. F. TPR Ref.	12/24	

**16oz** 55mm  
454gr



55mm



**MARTELO DE CARPINTEIRO**  
**MARTILLO DE OREJAS**  
**CLAW HAMMER**

**TIPO AMERICANO**

**CABO DE MADEIRA**  
**MANGO EN MADERA**  
**WOODEN HANDLE**



**20oz**  
**567gr**  
**29mm**

**CABO FIBRA VIDRO**  
**MANGO FIBRA DE VIDRIO**  
**FIBERGLASS HANDLE**



**16oz**  
**495gr**  
**25mm**



**22oz**  
**628gr**  
**27mm**

**CURTO /CORTO /SHORT**  
**CABO FIBRA VIDRO**  
**MANGO FIBRA DE VIDRIO**  
**FIBERGLASS HANDLE** **/TPR**



**CABO FIBRA VIDRO**  
**MANGO FIBRA DE VIDRIO**  
**FIBERGLASS HANDLE** **/TPR**



**20oz**  
**567gr**  
**29mm**



**8oz**  
**227gr**  
**25mm**

**CABO FIBRA VIDRO**  
**MANGO FIBRA DE VIDRIO**  
**FIBERGLASS HANDLE** **/TPR**  
**REFORÇADO /REFORZADO /REINFORCED**



**16oz**  
**454gr**  
**27mm**

Descrição: **Martelo de Carpinteiro**

Marca: **Mader Hand Tools**

N. Ref.	Especificação	Quant. Caixa:
61023	C. Madeira - 16 oz - 25 mm	6/36
61024	C. Madeira - 22 oz - 27 mm	6/36
61055	C. Fibra - 20 oz	6/24
61056	C. Fibra TPR - 8 oz - Curto	6/60
61021	C. Fibra TPR - 20 oz	6/24
61431	C. Fibra TPR - 16 oz - Reforç	6/24

### MARTELO MARTILLO HAMMER

**300gr** 22mm **385gr** 25 mm

**MARTELO DE PENNA**  
MARTILLO DE PEÑA  
JOINER'S HAMMER

**CABO DE MADEIRA**  
MANGO EN MADERA  
WOODEN HANDLE



**480gr**  
28mm

**MARTELO COFRAGEM**  
MARTILLO ENCOFRADOR  
ROOFING HAMMER

**CABO FIBRA VIDRO**  
MANGO FIBRA DE VIDRIO  
FIBERGLASS HANDLE **/TPR**



Descrição: **Martelo**

Marca: **Mader Hand Tools**

N. Ref.	Especificação	Quant. Caixa:
61029	Pena - 11 oz - C. Mad.	6/48
61030	Pena - 14 oz - C. Mad.	6/48
61031	Pena - 17 oz - C. Mad.	6/36
50714	Cofragem - 21 oz - C. Fibra TPR	6/24



**2oz**  
600gr  
29 mm

### MACHADO HACHA AXE

**600g**

**800g**

**1Kg**

**MACHADINHA**  
HACHA  
HATCHET

**CABO FIBRA VIDRO**  
MANGO FIBRA DE VIDRIO  
FIBERGLASS HANDLE **/TPR**



**1,5Kg**

**2Kg**



**CABO FIBRA VIDRO**  
MANGO FIBRA DE VIDRIO  
FIBERGLASS HANDLE  
**REFORÇADO /REFORZADO /REINFORCED**

Descrição: **Machado**

Marca: **Mader Hand Tools**

N. Ref.	Especificação	Quant. Caixa:
90654	600 gr - C. Fibra TPR	12
90655	800 gr - C. Fibra TPR	6/24
90656	1 Kg - C. Fibra TPR	6/24
61420	1,5 Kg - C. F. TPR Ref.	6
61421	2 Kg - C. F. TPR Ref.	6

### MACHADINHA

HACHA  
AXE



#### Cabo Fibra Vidro

Mango Fibra de Vidro  
Fiberglass Handle



**450 g**  
**200 mm**

N. Ref.	Descrição	Marca	Quant. Caixa
61418	MACHADINHA-MHT-450G	MADER HAND TOOLS	6

### MACHADINHA

HACHA  
AXE



**MULTIUSOS**  
MULTIFUNCTION

#### Monopieza - Cabo em Aço

Monopieza - Cable Acero  
Monopiece - Steel Cable



**300 g**  
**120 mm**

N. Ref.	Descrição	Marca	Quant. Caixa
61419	MACHADINHA-MHT-MULTIUSOS	MADER HAND TOOLS	6

com Chave Luneta: 19 - 15 - 10 mm  
con Llave Acodada: 19 - 15 - 10 mm  
with Ring Spanner: 19 - 15 - 10 mm

### MARTELO MARTILLO HAMMER

CABO FIBRA VIDRO / TPR  
MANGO FIBRA DE VIDRIO / TPR  
FIBERGLASS HANDLE



500gr  
25mm



MARTELO FAZ TUDO  
ALCOTANA PALA MARTILLO  
MASON'S HAMMER



MARTELO PEDREIRO  
ALCOTANA PALA MARTILLO  
MASON'S HAMMER

600gr  
29mm



PICADEIRA  
ALCOTANA PICO PALA  
MASON'S HAMMER



500gr

Descrição:	Martelo		
Marca:	Mader Hand Tools		
N. Ref.	Especificação	Quant.	Caixa:
61033	Faz Tudo - 18 oz - C. Fibra TPR	6/24	
61034	Pedreiro - 21 oz - C. Fibra TPR	6/24	
61032	Picadeira - 500 gr - C. Fibra TPR	24	

### ARRANCA PREGOS DESENCOFRADOR NAIL PULLER



30" x 3/4"  
19mm

Descrição:	Arranca Pregos		
Marca:	Mader Hand Tools		
N. Ref.	Especificação	Quant.	Caixa:
61041	30" x 3/4" (19mm)	12	
61042	36" x 3/4" (19mm)	10	



36" x 3/4"  
19mm

**MARRETA**  
MACETA  
STONING HAMMER

**QUADRADA**  
CUADRADA  
SQUARE



**CABO DE MADEIRA**  
MANGO EN MADERA  
WOODEN HANDLE



**CABO FIBRA VIDRO**  
MANGO FIBRA DE VIDRIO  
FIBERGLASS HANDLE

**/TPR**



1Kg



1,5Kg



1Kg



1Kg



1,5Kg



2Kg



**CABO FIBRA VIDRO**  
MANGO FIBRA DE VIDRIO  
FIBERGLASS HANDLE

**/TPR**

**TIPO ESPANHA**

Descrição: **Marreta**  
Marca: **Mader Hand Tools**

N. Ref.	Especificação	Quant. Caixa:
61046	Quad. - 1 Kg - C. Madeira	6/24
61047	Quad. - 1,5 Kg - C. Madeira	6/12
61057	Quad. - 1 Kg - C. Fibra TPR	6/24
61048	Quad. - 1 Kg - C. Fibra TPR	6/24
61049	Quad. - 1,5 Kg - C. Fibra TPR	6/12
61050	Quad. - 2 Kg - C. Fibra TPR.	6/12
61044	T. Espanha - 1 Kg - C. Fibra TPR	6/24



1Kg



**CABO FIBRA VIDRO**  
MANGO FIBRA DE VIDRIO  
FIBERGLASS HANDLE

**/TPR**

**MARRETA**  
MACETA  
STONING HAMMER

**QUADRADA**  
CUADRADA  
SQUARE

**CABO FIBRA VIDRO / TPR**  
MANGO FIBRA DE VIDRIO /  
FIBERGLASS HANDLE



3Kg



4Kg



5Kg



6Kg

**CABO FIBRA VIDRO / TPR**  
MANGO FIBRA DE VIDRIO /  
FIBERGLASS HANDLE  
**REFORÇADO / REFORZADO / REINFORCED**



4Kg



5Kg



Descrição: **Marreta**

Marca: **Mader Hand Tools**

N. Ref.	Especificação	Quant. Caixa:
61051	Quadrada - 3 Kg - C. Fibra TPR	4
61052	Quadrada - 4 Kg - C. Fibra TPR	4
61053	Quadrada - 5 Kg - C. Fibra TPR	4
61054	Quadrada - 6 Kg - C. Fibra TPR	4
61425	Quad. - 3 Kg - C. Fibra TPR Ref.	6
61426	Quad. - 4 Kg - C. Fibra TPR Ref	4
61427	Quad. - 5 Kg - C. Fibra TPR. Ref.	4

**PICARETA**  
MARTILLO PIQUETA  
RAILROAD PICK

**CABO FIBRA VIDRO**  
MANGO FIBRA DE VIDRIO / **TPR**  
FIBERGLASS HANDLE



2,5Kg



3Kg



3Kg

**REFORÇADO**  
**REFORZADO**  
**REINFORCED**

Descrição: Picareta		
Marca: Mader Hand Tools		
N. Ref.	Especificação	Quant. Caixa:
61035	2,5 Kg - C. Fibra TPR	6
61036	3 Kg - C. Fibra TPR	4
61433	3 Kg - C. Fibra TPR Reforçado	6

**MACETA DE CANTEIRO**  
MACETA CANTERO  
ROUND HAMMER

**CABO FIBRA VIDRO**  
MANGO FIBRA DE VIDRIO / **TPR**  
FIBERGLASS HANDLE



1Kg

Descrição: Maceta Canteiro		
Marca: Mader Hand Tools		
N. Ref.	Especificação	Quant. Caixa:
61065	1 Kg - C. Fibra TPR	4/16

### ESCOPRO ESCOPRO FLAT CHISEL

COM PROTECÇÃO  
CON PROTECCIÓN  
WITH PROTECTION



Descrição: Escopro com Protecção

Marca: Mader Hand Tools

N. Ref. Especificação Quant. Caixa:

50760 16 x 300 mm 6/36

50761 16 x 400 mm 6/24



16 x 300mm



16 x 400mm

### PONTEIRO PUNTERO CHISEL

COM PROTECÇÃO  
CON PROTECCIÓN  
WITH PROTECTION



Descrição: Ponteiro com Protecção

Marca: Mader Hand Tools

N. Ref. Especificação Quant. Caixa:

50762 16 x 300 mm 6/36

50763 16 x 400 mm 6/24



16 x 300mm



16 x 400mm

### ESCOPRO E PONTEIRO ESCOPLO Y PUNTERO FLAT CHISEL AND CHISEL

Ponteiro /Puntero /Chisel - 6, 8mm (87428-87429)  
Punção /Punzone /Punch - 2mm (87428-87429)  
Escopro /Escoplo /Flat Chisel - 10, 12, 16mm (87428-87429)  
Punção /Punzone /Punch - 15, 3, 4, 5, 6, 8mm (87429)

Descrição: Escopro e Ponteiro

Marca: Mader Hand Tools

N. Ref. Especificação Quant. Caixa:

87428 6 un 10

87429 12 un 10



6un



12un



### VAZADOR DE PANCADA PERFORADOR MANUAL HOLLOW PUNCH

3, 4, 5, 6, 8, 10mm



Descrição: Vazador de Pancada

Marca: Mader Hand Tools

N. Ref. Especificação Quant. Caixa:

51674 6 un 6

6un





### CABO FIBRA VIDRO MANGO FIBRA DE VIDRIO FIBERGLASS HANDLE

### CABO FIBRA VIDRO /TPR MANGO FIBRA DE VIDRIO /TPR FIBERGLASS HANDLE

para /to:  
**Martelo de Carpinteiro**  
Martillo de Orejas  
Claw Hammer



16oz



20oz

para /to:  
**Martelo de Bola**  
Martillo de Bola  
Ball Pein Hammer



16oz

para /to:  
**Marreta Quadrada**  
Maceta Cuadrada  
Square Stoning Hammer



1Kg



1,5Kg



2Kg

para /to:  
**Marreta Quadrada**  
Maceta Cuadrada  
Square Stoning Hammer



1Kg



2Kg

para /to:  
**Marreta Quadrada**  
Maceta Cuadrada  
Square Stoning Hammer



3Kg



4Kg



5Kg



6Kg

Descrição: Cabo Fibra Vidro / TPR

Marca: Mader Hand Tools

N. Ref.	Especificação	Quant. Caixa:
61468	p/ Martelo - 16 oz	80
61469	p/ Martelo - 20 oz	80
61470	p/ Martelo Bola - 16 oz	80
61471	p/ Marreta - 1 Kg	80
61472	p/ Marreta - 1,5 Kg	80
61473	p/ Marreta - 2 Kg	80
61460	p/ Marreta - 1 Kg	80
61461	p/ Marreta - 2 Kg	80
61462	p/ Marreta - 3 Kg - Longo	20
61463	p/ Marreta - 4 Kg - Longo	20
61464	p/ Marreta - 5 Kg - Longo	20
61465	p/ Marreta - 6 Kg - Longo	20
61466	p/ Picareta - 2,5 Kg - Longo	6
61467	p/ Picareta - 3 Kg - Longo	6



para /to:  
**Picareta**  
Martillo Piqueta  
Railroad Pick



2,5Kg



3Kg



### SERROTE MULTIUSOS SERRUCHO MULTIUSOS WALLBOARD SAW

Lâmina em aço endurecido e dentes extra afiados; Ideal para tomadas e projetores encastrados;  
Extremidade pontiaguda para perfurar gesso cartonado;  
Lamina en acero duro y dientes extra afilados;  
Ideal para tomas y proyectores ajustados;  
Hardened steel blade and extra-sharp teeth;  
Ideal for fitting sockets and downlights;  
Pointed end for piercing plasterboard;



Descrição: Serrote Multiusos - T/Faca  
Marca: Mader Hand Tools  
N. Ref. Especificação  
61015 150 mm  
Quant. Caixa: 12

**AÇO  
ACERO  
STILL**



**150mm**

### SERROTE COSTAS C/ ESQUADRIA SIERRA DE COSTILLA C/ CAJA INGLETES TENON SAW WITH MITRE BOX

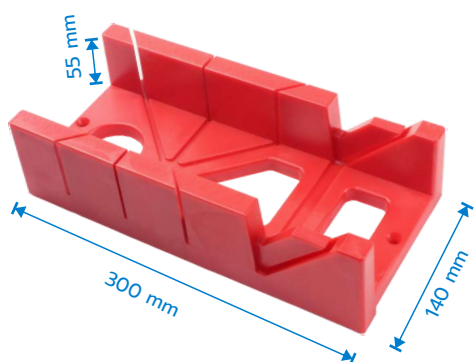

**CABO BI-MATERIAL  
MANGO BI-MATERIAL  
BI-MATERIAL HANDLE**



**300mm**

Descrição: Serrote Costas  
Marca: Mader Hand Tools  
N. Ref. Especificação  
61403 c/ Esquadria - 300 mm  
Quant. Caixa: 6



### CAIXA ESQUADRIA CAJA INGLETES MITRE BLOCK

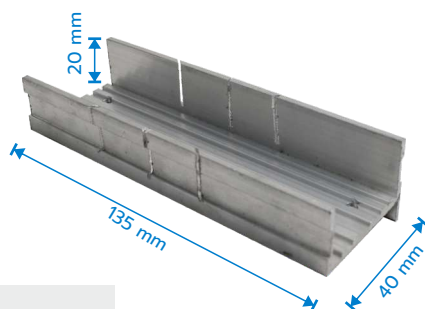

**METAL**



Descrição: Serrote Corte Ferro  
Marca: Mader Hand Tools  
N. Ref. Especificação  
61409 Caixa Esquadria - Metal  
Quant. Caixa: 6



### KIT SERROTES

JUEGO SERRUCHOS  
SAW KIT



**2**  
POSIÇÕES DE CORTE  
POSICIONES DE CORTE  
CUTTING POSITIONS

PUNHO P/ LÂMINA  
MANGO P/ CUCHILLA  
HANDLE FOR BLADE

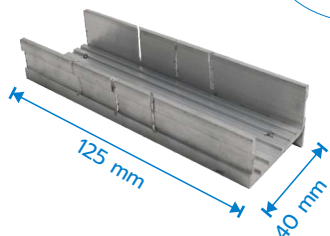

**4**

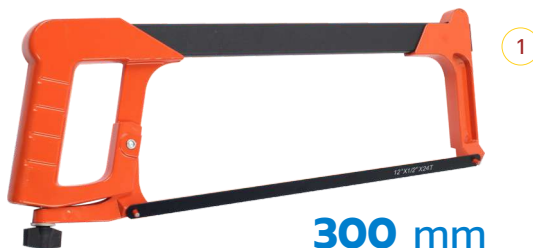

**300 mm**



**150 mm**



Kit **4un**

**1 un - 300mm**

Serrate c/ Esticador (Cabo Alumínio) c/ Lâmina | Serrucho c/ Tensor (Mango Alumínio)  
c/ Cuchilla | Hacksaw Frame (Aluminium Handle) w/ Blade

**1 un - 150mm** - Mini Serrate | Mini Serrucho | Mini Hacksaw

**1 un** - Punho p/ Lâmina | Mango p/ Cuchilla | Handle for Blade

**1 un** - Caixa Esquadria Metálica | Caja Ingletes Metálica | Metal Mitre Block

Descrição: Serrate Corte Ferro

Marca: Mader Hand Tools

N. Ref. Especificação

61401 Kit Serrote - 4 un

Quant. Caixa:

12

### SERRATE CORTE FERRO

SERRUCHO CORTE METAL  
METAL CUT HAND SAW

COM ESTICADOR  
CON TENSOR  
HACKSAW FRAME



**300mm**

**CABO PLÁSTICO**  
MANGO PLÁSTICO  
PLASTIC HANDLE



**300mm**

**CABO FERRO**  
MANGO HIERRO  
IRON HANDLE



**300mm**

**CABO ALUMÍNIO**  
MANGO ALUMINIO  
ALUMINIUM HANDLE

**2**  
POSIÇÕES DE CORTE  
POSICIONES DE CORTE  
CUTTING POSITIONS

Descrição: Serrate Corte Ferro

Marca: Mader Hand Tools

N. Ref. Especificação

30005 Cabo Plástico - 300 mm

Quant. Caixa:

48

30007 Cabo Metal - 300 mm

12

61402 Cabo Alumínio - 300 mm

12

### SERROTE COSTAS SERRUCHO COSTILLA TENON SAW

Madeira, Aglomerado  
Madera, Conglomerado  
Wood, Chipboard

Dentes tipo "CROSS JAPONÊS"  
Dientes tipo "CROSS JAPONÊS"  
Teeth like "JAPANESE CROSS"

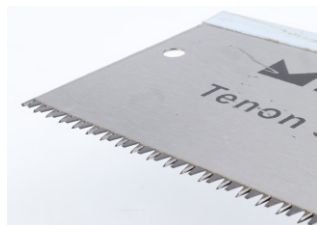

Cabo Bi-Matéria  
Mango Bi-Materia  
Bi-Material Cable



300mm



350mm

N. Ref.	Descrição
61404 » 61406	SERROTE COSTAS-MHT-300MM » 350MM

Marca	Quant. Caixa
MADER HAND TOOLS	1

### SERROTE FOLHA LARGA SERRUCHO CARPINTERO CARPENTER SAW

Madeira, Contraplacado, Aglomerado  
Madera, Contrachapado, Conglomerado  
Wood, Plywood, Chipboard

Dentes tipo "CROSS JAPONÊS"  
Dientes tipo "CROSS JAPONÊS"  
Teeth like "JAPANESE CROSS"

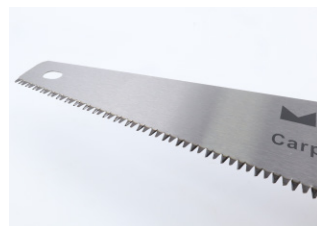

Cabo Bi-Matéria  
Mango Bi-Materia  
Bi-Material Cable



450mm



500mm

N. Ref.	Descrição
61398 » 61399	SERROTE F/LARGA-MHT-450MM » 500MM

Marca	Quant. Caixa
MADER HAND TOOLS	60

### LÂMINA CORTE FERRO LAMINA CORTE HIERRO IRON CUT BLADE

#### AÇO CARBONO



made in DINAMARCA



1un

#### HSS



made in DINAMARCA



1un

#### BI-METAL



made in DINAMARCA



1un

Compra mínima de 10 un por Ref.

#### BI-METAL



5160222516140521

3un



Descrição: Lâmina Corte Ferro

Marca: Mader Hand Tools

N. Ref. Especificação Quant. Caixa:

56037 Aço Carbono - 1 un 10/100

56038 HSS - 1 un 10/100

56039 Bi-Metal - 1 un 10/100

61405 Bi-Metal - 3 un 10

### LIMAS LIMAS FILE SET



**6"** 150mm

**QUADRADA**  
CUADRADA  
SQUARE



**8"** 200mm

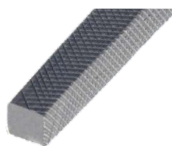

**PARALELA**  
FLAT

**P/ AFIAR CORRENTE**  
AFILADORA CADENA  
CORRUGATING FILE



**6"** 150mm



**3/16"**  
200mm

**REDONDA**  
ROUND

**3/16" P/ MOTOSERRA**

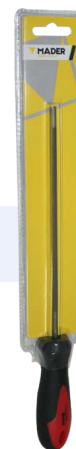

Descrição: Lima

Marca: Mader Hand Tools

N. Ref.	Especificação	Quant.	Caixa:
51605	Quadrada - 6"	10	
51606	Quadrada - 8"	6	
51613	Afia Corrente - 6" - Retângular	10	
52320	Afia Corrente - 3/16" - Redonda	6	

### LIMAS LIMAS FILE SET



**DIAMANTE**

**140mm**

5un

**GR 150**

- 1 - Meia Cana /Media Caña /Half Round
- 1 - Redonda /Round
- 1 - Paralela /Flat Parallel
- 1 - Quadrada /Cuadrada /Square
- 1 - Triângular /Triangular /Triangle

140mm



150mm



**150mm**

6un

**PRECISÃO**



- 1 - Meia Cana /Media Caña /Half Round
- 1 - Redonda /Round
- 2 - Paralela /Flat Parallel
- 1 - Quadrada /Cuadrada /Square
- 1 - Triângular /Triangular /Triangle

Descrição: Lima Precisão

Marca: Mader Hand Tools

N. Ref.	Especificação	Quant.	Caixa:
51634	140 mm - 5 un	10/50	
51632	6" - 150 mm - 6 un	6/48	

### LIXA LIJA SANDING PAPERS

**MADEIRA /METAL**  
**MADERA /METAL**  
**WOOD /METAL**

533 x 76mm



Descrição:	Lixa - Madeira - 533x76mm		
Marca:	Mader Hand Tools		
N. Re	Especificação		Quant. Caixa:
61085	Grão - Gr40 - 5 un		20
61086	Grão - Gr60 - 5 un		20
61087	Grão - Gr80 - 5 un		20
61088	Grão - Gr120 - 5 un		20



**Gr40** 5un



**Gr60** 5un



**Gr80** 5un



**Gr120** 5un

### LIXA LIJA SANDING PAPERS

**MADEIRA** 5un  
**MADERA**  
**WOOD**

230 x 280mm



Descrição:	Lixa - Madeira		
Marca:	Mader Hand Tools		
N. Ref.	Especificação		Quant. Caixa:
31258	Grão - Gr40 - 5 un		20
31259	Grão - Gr60 - 5 un		20
31260	Grão - Gr80 - 5 un		20
31261	Grão - Gr100 - 5 un		20
31262	Grão - Gr150 - 5 un		20

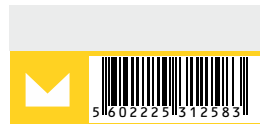

**Gr40**



**Gr60**



**Gr80**



**Gr100**



**Gr150**

### LIXA LIJA SANDING PAPERS

**MADEIRA** 50un  
**MADERA**  
**WOOD**

230 x 280mm



Descrição:	Lixa - Madeira		
Marca:	Mader Hand Tools		
N. Ref.	Especificação		Quant. Caixa:
61080	Grão - Gr40 - 50 un		20
61081	Grão - Gr60 - 50 un		20
61082	Grão - Gr80 - 50 un		20
61083	Grão - Gr100 - 50 un		20
61084	Grão - Gr150 - 50 un		20



**Gr40**



**Gr60**



**Gr80**



**Gr100**



**Gr150**

**LIXA**  
LIJA  
SANDING PAPERS

**METAL** 1un  
230 x 280mm



Descrição: Lixa - Metal		
Marca: Mader Hand Tools		
N. Ref.	Especificação	Quant. Caixa:
31270	00-Grão - Gr40 - 1 un	50
31273	0-Grão - Gr60 - 1 un	50
31275	1,5-Grão - Gr100 - 1 un	50



**LIXA**  
LIJA  
SANDING PAPERS

**METAL** 5un  
230 x 280mm



Descrição: Lixa - Metal		
Marca: Mader Hand Tools		
N. Ref.	Especificação	Quant. Caixa:
31250	Grão - Gr40 - 5 un	20
31251	Grão - Gr60 - 5 un	20
31252	Grão - Gr80 - 5 un	20
31253	Grão - Gr100 - 5 un	20
31254	Grão - Gr150 - 5 un	20



**RASPADOR METÁLICO**  
RASCADOR METÁLICO  
METAL SCRAPER

**LÂMINA P/ RASPADOR**  
LÂMINA P/ RASCADOR  
SCRAPER BLADE

**CABO LONGO**  
CABLE LARGO  
LONG HANDLE

**METAL**



Descrição: Raspador		
Marca: Mader Hand Tools		
N. Ref.	Especificação	Quant. Caixa:
20097	Cabo Longo - 102x320mm	12
20098	Lâmina - 102x14mm - 10un	24

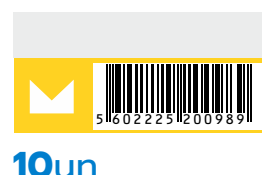



## FAÇA DE ALCATIFA CORTADOR UTILITY KNIFE

0,38x9x80mm

LÂMINA  
CUCHILLA  
BLADE 1



LÂMINA  
CUCHILLA  
BLADE 1+2

0,38x9x80mm

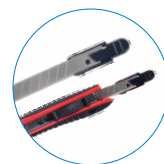

LÂMINA  
CUCHILLA  
BLADE 1+2

0,5x18x100mm



0,5x18x100mm

LÂMINA  
CUCHILLA  
BLADE 1



LÂMINA  
CUCHILLA  
BLADE 1+2

0,7x25x126mm



0,5x18x110mm  
ABS+TPR

LÂMINA  
CUCHILLA  
BLADE 1



LÂMINA  
CUCHILLA  
BLADE 1

0,5x18x110mm  
ALUMÍNIO



Descrição: **Faca de Alcatifa**

Marca: **Mader Hand Tools**

N. Ref.	Especificação	Quant.	Caixa:
61241	0,38x9x80mm - 1 Lâmina	24	24
61243	0,38x9x80mm - 1+2 Lâmina	24	24
61242	0,5x18x110mm - 1 Lâmina	24	24
61244	0,5x18x110mm - 1+2 Lâmina	24	24
61239	0,5x18x110mm - ABS+TPR 1 Lâmina	24	24
61245	0,7x25x126mm - 1+2 Lâmina	24	24
61246	0,5x18x110mm - ALUMÍNIO 1 Lâmina	24	24
61247	10Un - 0,38x9x80mm	20	20
61248	10Un - 0,5x18x100mm	20	20
61249	10Un - 0,7x25x126mm	10	10



LÂMINAS  
CUCHILLAS  
BLADES



0,38x9x80mm  
10un



0,5x18x100mm  
10un



0,7x25x126mm  
10un

### FAÇA DE ALCATIFA CORTADOR UTILITY KNIFE

**SORTIDOS  
SURTIDOS  
MISCELANEOUS**



LÂMINA  
CUCHILLA  
BLADE **1**

**0,5x18x100mm**



**24un**  
EXPOSITOR | EXHIBITOR

Descrição: Faca de Alcatifa - Expositor  
 Marca: Mader Hand Tools  
 N. Ref. Especificação Quant. Caixa:  
 61240 24Un - 0,5x18x100mm - 1 Lâmina 1

### AFIADOR DE FACAS AFILADOR CUCHILLOS KNIFE SHARPENER

**COM VENTOSA  
CON VENTOSA  
WITH SUCTION PAD**



Descrição: Afiador de Facas  
 Marca: Mader Hand Tools  
 N. Ref. Especificação Quant. Caixa:  
 61412 c/ Ventosa - Duplo 10/90

**DUPLO  
DOBLE  
DOUBLE**



### CORTADOR DE VIDRO CORTADOR DE VIDRIO GLASS CUTTER

**5"**



**125mm  
6,5mm**

Descrição: Corta Vidro  
 Marca: Mader Hand Tools  
 N. Ref. Especificação Quant. Caixa:  
 98893 5" 20

### MÁQUINA AGRAFAR GRAPADORA STAPLE GUN

Agrafes /Grapas /Staples **ref. 53**

**200** Agrafes  
Grapas  
Staples



**4mm - 8mm**



**100** Agrafes  
Grapas  
Staples



**4mm - 14mm**

**C/ REGULAÇÃO DE PRESSÃO**  
CON REGULACIÓN DE PRESIÓN  
WITH PRESSURE REGULATION

**C/ REGULAÇÃO DE PRESSÃO**  
CON REGULACIÓN DE PRESIÓN  
WITH PRESSURE REGULATION

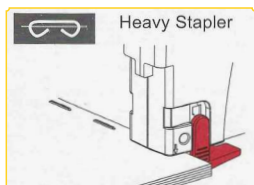

Heavy Stapler

Agrafa até 50 Folhas  
Grapa hasta 50 Hojas

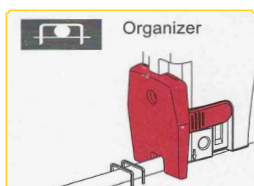

Organizer

Cabos Finos/Decoração  
Cables Finos/Decoração

# 3IN1



**6mm - 12mm**

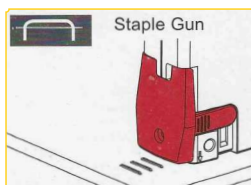

Staple Gun

Estofos/Posteres/Tecidos  
Capitonés/Carteles/Tejidos

**100**  
Agrafes  
Grapas  
Staples

Descrição:	Máquina Agrafar	
Marca:	Mader Hand Tools	
N. Ref.	Especificação	Quant. Caixa:
61216	4 - 8 mm - 200 un	10
61215	4 - 14 mm - 100 un	10
61217	6 - 12 mm - 100 un - 3in1	8

### AGRAFES GRAPAS STAPLES

**ref. 53**



**6mm**  
1000un



**8mm**  
500un

Descrição:	Agrafe p/ Máquina Agrafar Manual	
Marca:	Mader Hand Tools	
N. Ref.	Especificação	Quant. Caixa:
33210	53/ 6mm - 1000 un	20
33211	53/ 8mm - 500 un	20
33212	53/ 10mm -500 un	20
33213	53/ 12mm - 500 un	20



**10mm**  
500un



**12mm**  
500un

### MEDIDOR A LASER MEDIDOR DE LÁSER LASER DISTANCE METER



### LASER VERMELHO LÁSER ROJO RED LASER



0.05 - 50m

Medição de área  
Medição de volume  
Teorema de Pitágoras  
Adiciona e subtrai medidas

Medición de la superficie  
Medición del volumen  
Teorema de Pitágoras  
Sumar y restar medidas

Area measurement  
Volume measurement  
Pythagoras theorem  
Add and subtract measurements

Precisão / Precisión / Precision	± 2mm
Autonomia / Autonomy	8000x Medição Simples
Bateria / Batería / battery	2x 15V AAA

N. Ref.	Descrição	Marca	Quant. Caixa
84660	MEDIDOR LASER-MHT-50M VERMELHO	MADER HAND TOOLS	80

### NÍVEL A LASER NIVEL DE LÁSER LASER LEVEL



### LASER VERDE LÁSER VERDE GREEN LASER



20m

Precisão / Precisión / Precision	± 3mm/10m
Autonomia / Autonomy	4h
Bateria / Batería / battery	2x 15V AA
Classificação IP / Clasificación IP / IP Rating	IP54

N. Ref.	Descrição	Marca	Quant. Caixa
30540	NIVEL LASER-MHT-20M CRUZ VERDE	MADER HAND TOOLS	30



Auto-Nivelamento: 4° ± 1°  
Autonivelación: 4° ± 1°  
Self-Leveling: 4° ± 1°

### FITA MÉTRICA CINTA MÉTRICA MEASURING TAPE



**2** TRAVÃO  
FRENO  
BRAKE



**16mm x 3m**



**19mm x 5m**

**1** TRAVÃO  
FRENO  
BRAKE



**25mm x 5m**



**25mm x 8m**

Descrição: Fita Métrica

Marca: Mader Hand Tools

N. Ref. Especificação

Quant. Caixa:

84645 2 Travão - 16 mm x 3 m

12/120

84646 2 Travão - 19 mm x 5 m

12/120

84643 1 Travão - 25 mm x 5 m

10/100

84644 1 Travão - 25 mm x 8 m

6/60

### FITA MÉTRICA CINTA MÉTRICA MEASURING TAPE



**3** TRAVÕES  
FRENOS  
BRAKES



**16mm x 3m**



**19mm x 5m**



**25mm x 8m**



**32mm x 10m**

Descrição: Fita Métrica

Marca: Mader Hand Tools

N. Ref. Especificação

Quant. Caixa:

84600 3 Travões - 16 mm x 3 m

12/120

84601 3 Travões - 19 mm x 5 m

12/120

84602 3 Travões - 25 mm x 8 m

10/100

84608 3 Travões - 32 mm x 10 m

6/60

### FITA MÉTRICA FLEXÓMETRO MEASURE TAPE

Travão » 1  
Freno » 1  
Brake » 1



**19mm x 5m**

Expositor com 12 un  
Expositor con 12 un  
Display stand with 12 un

N. Ref.	Descrição	Marca	Quant. Caixa
84609	FITA MÉTRICA-MHT-5MX19MM - EXPOSITOR 12un	MADER HAND TOOLS	12

### FITA MÉTRICA CINTA MÉTRICA MEASURING TAPE

### FIBRA DE VIDRO FIBRA DE VIDRIO FIBERGLASS



Descrição:	Fita Métrica	Quant. Caixa:
Marca:	Mader Hand Tools	
N. Ref.	Especificação	
84617	Fibra de Vidro - 20 m	60
84623	Fibra de Vidro - 30 m	60
84624	Fibra de Vidro - 50 m	60



**20m**



**30m**



**50mm**

### PAQUÍMETRO CALIBRADOR VERNIER CALIPER

**INOX**

Para Medidas /To Measures:

**Interiores e Exteriores** /Internal and External

Escala /Scale

**150 mm**

Botão de Bloqueio /Botón de Bloqueo /Lock Button  
Roda de Ajuste /Rueda de Ajuste /Adjusting Wheel

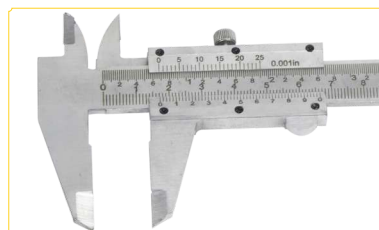

**150mm**

Descrição: Paquímetro

Marca: Mader Hand Tools

N. Ref. Especificação

61005 Graduado - 150 mm

Quant. Caixa:

20

### NÍVEL ALUMÍNIO NIVEL ALUMINIO ALUMINUM LEVEL

**GRADUADO  
GRADUATE**



**3** BOLHAS  
BURBUJAS  
BUBBLES



**50cm**



**60cm**



**80cm**



**100cm**

Descrição: Nível Graduado Tubular - Alumínio

Marca: Mader Hand Tools

N. Ref. Especificação

30525 92 - 3 Bolhas - 50 cm

Quant. Caixa:

50

30526 92 - 3 Bolhas - 60 cm

50

30523 92 - 3 Bolhas - 80 cm

30

30522 92 - 3 Bolhas - 100 cm

30

Equipados com **3 bolhas de cor anti-choque**

(1 vertical, 1 horizontal e 1 declive 45°),

que estão ligadas permanentemente ao corpo, para uma precisão consistente na posição normal de trabalho.

**Reversibilidade** boa ( possuem a mesma exatidão ao serem usados invertidos).

Tem **escala graduada** em milímetros.

**MAGNÉTICO  
MAGNETIC**

### NÍVEL ALUMÍNIO NIVEL ALUMINIO ALUMINUM LEVEL



**3** BOLHAS  
BURBUJAS  
BUBBLES



**60cm**



**80cm**



**100cm**



**120cm**

Descrição: Nível - Alumínio

Marca: Mader Hand Tools

N. Ref. Especificação

30532 3 Bolhas - 60 cm

Quant. Caixa:

1

30533 3 Bolhas - 80 cm

1

30534 3 Bolhas - 100 cm

1

30535 3 Bolhas - 120 cm

1

Equipados com **3 bolhas de cor anti-choque**

(1 vertical, 1 horizontal e 1 declive 45°),

que estão ligadas permanentemente ao corpo, para uma precisão consistente na posição normal de trabalho.

**Magnético**

### NÍVEL ALUMÍNIO NIVEL ALUMINIO ALUMINUM LEVEL



#### GARANTIA ANTI-CHOQUE

Os níveis de alumínio tubulares têm a secção em **caixão reforçado**, que lhes confere uma maior resistência e são revestidos com uma camada dura **resistente à abrasão** em epoxy amarelo.

A precisão destes níveis requer uma elevação entre 0,5 e 1,0 mm por metro, para centrar a bolha na posição normal de trabalho.

Equipados com **3 bolhas de cor anti-choque** (1 vertical, 1 horizontal e 1 declive 45°), que estão ligadas permanentemente ao corpo, para uma precisão consistente na posição normal de trabalho.

**Reversibilidade** boa ( possuem a mesma exatidão ao serem usados invertidos ).

Tem **escala graduada** em milímetros.

Garantia de 5 anos contra quebra e vazamento (bolhas).

#### \* NÃO TÊM ESCALA GRADUADA



40cm



50cm



60cm



80cm



100cm



\*120cm



\*150cm



\*180cm



\*200cm

Descrição: Nível Graduado Tubular - Alumínio

Marca: Vola

N. Ref.	Especificação	Quant. Caixa:
91025	245 - 3 Bolhas - 40 cm	10
91030	245 - 3 Bolhas - 50 cm	10
91035	245 - 3 Bolhas - 60 cm	10
91040	245 - 3 Bolhas - 80 cm	10
91045	245 - 3 Bolhas - 100 cm	10
91065	245 - 3 Bolhas - 120 cm*	10
91070	245 - 3 Bolhas - 150 cm*	10
91073	245 - 3 Bolhas - 180 cm*	10
91075	245 - 3 Bolhas - 200 cm*	10

### ESQUADRO ESCUADRA SQUARE



25cm



30cm

Descrição: Esquadro Graduado - Alumínio

Marca: Vola

N. Ref.	Especificação	Quant. Caixa:
91090	270 - 25 cm	12
91092	270 - 30 cm	12
91094	270 - 35 cm	12
91096	270 - 40 cm	12
91098	270 - 50 cm	12



35cm



40cm



50cm



### GRAMPO APERTO TORNILLO APRIETE CLAMP



200mm



250mm

50mm



250mm



300mm



400mm



500mm

80mm

Descrição: Grampo Aperto

Marca: Mader Hand Tools

N. Ref.	Especificação	Quant. Caixa:
61070	50 x 200 mm	50
61071	50 x 250 mm	50
61072	80 x 250 mm	20
61073	80 x 300 mm	20
61074	80 x 400 mm	10
61075	80 x 500 mm	10
61067	120 x 1000 mm	10



1000mm

120mm

### GRAMPO TORNILLO CLAMP

### MOLA MUELLE SPRING CLAMP



110mm  
Ref: 100



170mm  
Ref: 150



230mm  
Ref: 225



300mm



600mm



TIPO  
TYPE F



Descrição: Grampo

Marca: Mader Hand Tools

N. Ref.	Especificação	Quant. Caixa:
61077	Mola - 100 - 110 mm	160
61078	Mola - 150 - 170 mm	120
61079	Mola - 225 - 230 mm	80
61068	tipo F - 300 mm	36
61069	tipo F - 600 mm	36

### MÁQUINA MASTIQUE

PISTOLA DE CARTUCHOS SILICONA  
SKELETON CAULKING GUN



**CROMADA**  
CROMADO  
CHROME



**TIPO JAPÃO**



**QUALIDADE**



**9"** 1º PREÇO



**9"**



**9"**



**9"**



**ALUMÍNIO**  
ALUMINUM  
**QUALIDADE**



**9"**



**ALUMÍNIO**  
ALUMINUM



**9"**

**PROFISSIONAL**



**ALUMÍNIO**  
ALUMINUM



**15"**

**PROFISSIONAL**

Descrição: Pistola Mastique

Marca: Mader Hand Tools

N. Ref.	Especificação	Quant. Caixa:
61200	Tipo Japão - 9"	24
42240	1565 - 9"	24
42241	726 - 9" Cromada	24
42247	Qualidade - 9"	24
42249	Qualidade - 9" Alumínio	12
57601	Profissional - 9" Alumínio	12
42251	Profissional - 15" Alumínio	12
42252	Bicos para 42251 - 5un	-

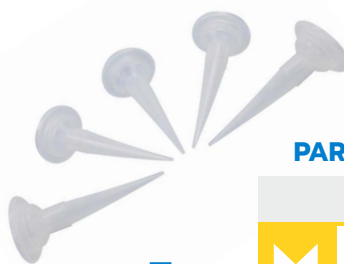

**5un**

**PARA / TO 42251**



### PISTOLA ESPUMA PISTOLA ESPUMA FOAM GUN



Descrição: Pistola p/ Espuma  
 Marca: Mader Hand Tools  
 N. Ref. Especificação  
 63271 CY-066

Quant. Caixa:  
 20

### DESENTUPIDOR DE CANOS LIMPIADORA DE DESAGUES DRAIN CLEANER

**P/ LIMPEZA DE TUBAGENS E CANALIZAÇÕES**  
**P/ LIMPIEZA DE TUBERÍAS Y DESAGUES**  
**FOR PIPE AND PLUMBING CLEANING**



Descrição: Desentupidor de Canos  
 Marca: Mader Hand Tools  
 N. Ref. Especificação  
 34135 Sonda SF-62 - 5 m

Quant. Caixa:  
 1

5m

### JOELHEIRA RODILLERA KNEE PAD



**Borracha**  
**Goma**  
**Rubber**



**Tamanho /Tamaño / Size: UNIVERSAL**  
**Ajuste Seguro /Secure Fit**



Descrição: Joelheira  
 Marca: Mader Hand Tools  
 N. Ref. Especificação  
 56267 Borracha  
 61094 Gel

Quant. Caixa:  
 10  
 12

GEL

### BETUMADEIRA ESPÁTULA SCRAPER

**MULTIUSOS**  
MULTIUSOS  
MULTI-PURPOSE



**6in1**

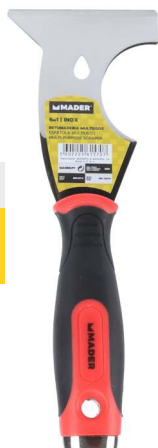

**INOX**



**16in1**



**INOX**



**25mm**



**50mm**



**75mm**



**100mm**

**LARGA**  
ANCHA  
LARGE



**INOX**



**150mm**



**200mm**



**250mm**



**300mm**

Descrição: **Betumadeira - Inox**

Marca: **Mader Hand Tools**

N. Ref. Especificação

61570 Multiusos - 6in1

61571 Multiusos - 16in1

61560 25 mm

61561 50 mm

61562 75 mm

61563 100 mm

61564 Larga - 150 mm

61565 Larga - 200 mm

61566 Larga - 250 mm

61567 Larga - 300 mm

61575 Angular - 155x60 mm

Quant. Caixa:

12

12

12

12

12

12

12

12

12

12

12

12

**ANGULAR**  
**ANGULAR**  
**HALF ROUND**



**INOX**



**155x60mm**

### BETUMADEIRA ESPÁTULA SCRAPER

### INOX

### CABO DE BORRACHA MANGO EN GOMA RUBBER HANDLE



**25mm**  
1"



**50mm**  
2"



**75mm**  
3"



**100mm**  
4"



**125mm**  
5"

Descrição: Betumadeira - Inox

Marca: Mader Hand Tools

N. Ref.	Especificação	Quant. Caixa:
61255	C. Borracha - 1" - 25mm	12
61256	C. Borracha - 2" - 50mm	12
61257	C. Borracha - 3" - 75mm	12
61258	C. Borracha - 4" - 100mm	12
61259	C. Borracha - 5" - 125mm	12

### COLHERIM PEDREIRO PALETIN ALBAÑIL BRICKLAYING TROWEL

**AÇO**  
ACERO  
STEEL

**CABO DE MADEIRA**  
MANGO EN MADERA  
WOODEN HANDLE

**CANTO CORTADO**  
ESQUINA CORTADA  
CUT CORNER

**PONTA REDONDA**  
PUNTA REDONDA  
ROUND TIP



**150mm** 6"

**AÇO**  
ACERO  
STEEL

**CABO DE MADEIRA**  
MANGO EN MADERA  
WOODEN HANDLE

**CANTO RETO**  
ESQUINA RECTA  
STRAIGHT CORNER

**PONTA BICUDA**  
PUNTA PICUDA  
POINTED TIP

**PONTA REDONDA**  
PUNTA REDONDA  
ROUND TIP



**150mm** 6"



**150mm** 6"

Descrição: Colherim Pedreiro

Marca: Mader Hand Tools

N. Ref.	Especificação	Quant. Caixa:
30672	<b>Aço - C. Madeira - P Redonda</b> Canto Cortado - 6" - 150mm	6/60
98876	Ponta Bicuda - 150mm	12
98877	Ponta Redonda - 150mm	12

**COLHER PEDREIRO**  
PALETIN ALBAÑIL  
BRICKLAYING TROWEL

**AÇO** **PONTA REDONDA**  
**ACERO** **PUNTA REDONDA**  
**STEEL** **ROUND TIP**

**CANTO RETO**  
**ESQUINA RECTA**  
**STRAIGHT CORNER**

**CABO DE MADEIRA**  
**MANGO EN MADERA**  
**WOODEN HANDLE**



**200mm**  
8"



**230mm**  
9"



**215mm**  
8-½"



**220mm**  
8-½"



**240mm**  
9-½"



**CABO ABS+TPR /MANGO ABS+TPR /ABS+TPR HANDLE**

Descrição: Colher Pedreiro - Ponta Redonda		
Marca: Mader Hand Tools		
N. Ref.	Especificação	Quant. Caixa:
<b>Aço - Cabo Madeira</b>		
30673	8" - 200mm	6/60
30674	9" - 230mm	6/60
98881	215mm	12
98882	220mm	12
98883	240mm	12
<b>Aço Carbono - Cabo ABS+TPR</b>		
61580	125 mm	12
61581	150 mm	12
61582	175 mm	12
61583	200 mm	12
61584	225 mm	12



**125mm**



**150mm**



**175mm**



**200mm**



**225mm**

**COLHER PEDREIRO**  
PALETIN ALBAÑIL  
BRICKLAYING TROWEL

**AÇO** **CABO DE MADEIRA**  
**ACERO** **MANGO EN MADERA**  
**STEEL** **WOODEN HANDLE**

**CANTO CORTADO** **PONTA REDONDA**  
**ESQUINA CORTADA** **PUNTA REDONDA**  
**CUT CORNER** **ROUND TIP**



Descrição: Colher Pedreiro		
Marca: Mader Hand Tools		
N. Ref.	Especificação	Quant. Caixa:
<b>Aço - C. Madeira - P Redonda</b>		
98879	Canto Cortado - 215mm	12
98887	Canto Cortado - 220mm	12
98888	Canto Cortado - 240mm	12



**215mm**  
8-½"



**220mm**  
8-½"



**240mm**  
9-½"

### COLHER PEDREIRO PALETIN ALBAÑIL BRICKLAYING TROWEL

**AÇO**  
ACERO  
STEEL

**CABO DE MADEIRA**  
MANGO EN MADERA  
WOODEN HANDLE

**CANTO CORTADO**  
ESQUINA CORTADA  
CUT CORNER

**PONTA REDONDA**  
PUNTA REDONDA  
ROUND TIP



Descrição:	Colher Pedreiro	
Marca:	Mader Hand Tools	
N. Ref.	Especificação	Quant. Caixa:
	<b>Aço - C. Madeira - P Redonda</b>	
30670	Canto Cortado - 8" - 200mm	6/60
30671	Canto Cortado - 9" - 225mm	6/60



**200mm**  
8"



**230mm**  
9"

### TALOCHA DE PEDREIRO LLANA DE PEDRERO PLASTERING TROWEL

**AÇO** **CABO DE PLÁSTICO**  
ACERO **MANGO EN PLASTICO**  
STEEL **PLASTIC HANDLE**



**280x130mm**

**DENTADA**  
W/ TEETH



**LISA**  
FLAT



**280x130mm**



**280x125mm**

**AÇO** **CABO ABS+TPR**  
ACERO **MANGO ABS+TPR**  
STEEL **ABS+TPR HANDLE**



**280x125mm**

**INOX**

**CABO DE BORRACHA**  
MANGO EN GOMA  
RUBBER HANDLE



**DENTADA**  
W/ TEETH



**280x114mm**



**LISA**  
FLAT



**280x114mm**

Descrição:	Taloche Pedreiro	
Marca:	Mader Hand Tools	
N. Ref.	Especificação	Quant. Caixa:
56248	Aço - Dent. - C. Plast. - 280mm	10
56247	Aço - Lisa - C. Plast. - 280mm	10
61595	Aço - Dent. - C. ABS+TPR - 280mm	12
61590	Aço - Lisa - C. ABS+TPR - 280mm	12
56232	Inox - Dent. - C. Borrac. - 280mm	6
56231	Inox - Lisa - C. Borrac. - 280mm	6

### TALOCHA DE PEDREIRO

LLANA DE PEDREIRO  
PLASTERING TROWEL

PLÁSTICA  
PLASTIC

CIMENTO  
CEMENTO  
CONCRETE



355x55x55mm

EXTERIOR  
OUTSIDE



Pilar  
Cornerstone



355x55x55mm

INTERIOR  
INSIDE



330x30mm

Nº1



380x50mm

Nº2



380x70mm

Nº3



Cantos  
Esquina  
Corner



265x160mm

Nº1



340x217mm

Nº2



415x260mm

Nº3



Bico /Pico /Beak



Nº1

265x160mm



Descrição Talocha Pedreiro

Marca: Mader Hand Tools

N. Ref. Especificação Quant. Caixa:

99997	p/ Pilar - Exterior	6
99996	p/ Pilar - Interior	6
99970	Plástica - Cantos - Nº1	6
99971	Plástica - Cantos - Nº2	6
99972	Plástica - Cantos - Nº3	6
99994	Plástica - Nº1	25
99995	Plástica - Nº2	30
99993	Plástica - Nº3	15
99992	Plástica - Bico - Nº1	25
61600	Poliuretano - 240x120 mm	60
61601	Poliuretano - 280x140 mm	60
61602	Poliuretano - 320x180 mm	60

POLIURETANO  
POLYURETHANE



240x120mm



280x140mm



320x180mm





### TALOCHA DE PEDREIRO

LLANA DE PEDRERO  
PLASTERING TROWEL

**CABO PLÁSTICO**  
MANGO PLÁSTICO  
PLASTIC HANDLE



**ESPONJA**  
SPONGE  
Nº1



**265x160mm**



**CABO PLÁSTICO / ALUMINÍO**  
MANGO PLÁSTICO / ALUMINIO  
PLASTIC / ALUMINIUM HANDLE



**ESPONJA**  
SPONGE



**240x100mm**

**CABO PLÁSTICO / PLÁSTICO**  
MANGO PLÁSTICO / PLÁSTICO  
PLASTIC / PLASTIC HANDLE



**BORRACHA**  
GOMA  
RUBBER



**240x100mm**

**CABO PLÁSTICO / ALUMINÍO**  
MANGO PLÁSTICO / ALUMINIO  
PLASTIC / ALUMINIUM HANDLE



**BORRACHA/ESPONJA**  
GOMA/ESPONJA  
RUBBER/SPONGE

Descrição:	Talocha Pedreiro		
Marca:	Mader Hand Tools		
N. Ref.	Especificação	Quant.	Caixa:
20575	Esponja - C. Plast. - Nº 1	25	
56233	Esponja - C. Plast./Alum. - 240mm	6	
56246	Borracha - C. Plast. - 240mm	6	
56235	Borr./Esp. -C. Plast./Alum. -240mm	6	
56234	Borr./Esp. -C. Plast./Alum. -300mm	6	



**240x100mm**



**300x100mm**

### ESPONJA DE PEDREIRO

ESPONJA DE PEDRERO  
MASONRY SPONGE



**170mm**



**170 x 110 x 55 mm**

Descrição:	Esponja p/ Pedreiro		
Marca:	Mader Hand Tools		
N. Ref.	Especificação	Quant.	Caixa:
56272	Amarela - 170x110x55mm	12/240	
56273	Amarela - 190x140x60mm	12/240	

**190mm**



**190 x 140 x 60 mm**

### LÁPIS CARPINTEIRO E AFIADORA LÁPIZ CARPINTERO Y SACAPUNTAS CARPENTER PENCIL AND SHARPENER



4 + 1un

Descrição: Lápis Carpinteiro  
 Marca: Mader Hand Tools  
 N. Ref. Especificação Quant. Caixa:  
 31572 c/ Afiadeira - 5 un 10/100

### PÓ » MARCADOR POLVO » TRAZADOR POWDER » CHALK LINE



115gr

Descrição: Pó Marcador  
 Marca: Mader Hand Tools  
 N. Ref. Especificação Quant. Caixa:  
 52215 Azul - 115 gr 24/96

### MARCADOR DE RETAS CORDEL DE TRAZADO CHALK LINE REEL



30 m

COM NÍVEL  
CON NIVEL  
WITH LEVEL

Descrição: Marcador de Retas  
 Marca: Mader Hand Tools  
 N. Ref. Especificação Quant. Caixa:  
 52222 Marcador + Nível - 30m 12

### KIT MARCADOR DE RETAS KIT CORDEL DE TRAZADO CHALK LINE REEL SET

Marcador Retas /Cordel Trazado /Chalk Line Reel:  
**30m**  
 Pó » Marcador /Polvo » Trazado /Chalk Line Powder:  
**115g**  
 Nível /Nivel /Level



3 un

COM NÍVEL  
CON NIVEL  
WITH LEVEL

Descrição: Marcador de Retas - Kit  
 Marca: Mader Hand Tools  
 N. Ref. Especificação Quant. Caixa:  
 52221 Marcador + Pó + Nível - 3 un 12/48

**PRUMO LATÃO**  
PLOMADA LATÓN  
BRASS PLUMB-LINE



**TIPO PIÃO**  
TIPO PEONZA  
SPINNING TOP



**N°4**



**N°5**

Descrição:	Prumo Latão	Quant. Caixa:	
Marca:	Mader Hand Tools		
N. Ref.	Especificação		
43960	Tipo Pião - N° 4		1
43961	Tipo Pião - N° 5		1
43957	Tipo Pião - N° 6		1
43958	Tipo Pião - N° 7		1
43959	Tipo Pião - N° 8		1



**N°6**



**N°7**



**N°8**

**FIO » MARCADOR**  
HILO » CORDEL TRAZADO  
REEL BUILDERS LINE



**75m**

Descrição:	Fio Marcador	Quant. Caixa:	
Marca:	Mader Hand Tools		
N. Ref.	Especificação		
61019	Amarelo - 75 m		1/72

**FIO » POLIPROPILENO**  
HILO » POLIPROPILENO  
LINE » POLYPROPYLENE



**150m**

Descrição:	Fio Polipropileno	Quant. Caixa:	
Marca:	Mader Hand Tools		
N. Ref.	Especificação		
61017	150 m		12

### GAMELA P/ CIMENTO BANDEJA P/ HORMIGÓN CEMENT TRAY



#: 420x310mm  
#: 310x210mm  
h: 95mm



**7,5L - n°1**



#: 490x400mm  
#: 360x280mm  
h: 110mm

**15L - n°2**



#: 640x470mm  
#: 510x320mm  
h: 170mm



**35L - n°3**

Descrição: **Gamelas p/ Cimento**

Marca: **Mader Hand Tools**

N. Ref.	Especificação	Quant.	Caixa:
99991	n° 1 - 7,5 L - c/ Asas	6	
99058	n° 2 - 15 L	6	
71070	n° 3 - 35 L	6	

### CELHA PRETA CAPAZO NEGRO BLACK CARRYCOT



**ref: 23**

φ: 350mm  
h: 300mm



**ref: 38**

φ: 450mm  
h: 320mm

Descrição: **Celha Preta**

Marca: **Mader Hand Tools**

N. Ref.	Especificação	Quant.	Caixa:
99900	ref. 23	25	
99901	ref. 38	25	

### BALDE PLÁSTICO P/ CONSTRUÇÃO CUBO DE PLÁSTICO P/ CONSTRUCCIÓN PLASTIC BUCKET CONSTRUCTION



**10L**

φ: 260mm  
h: 250mm



**15L**

φ: 315mm  
h: 280mm

Descrição: **Balde Plástico p/ Construção**

Marca: **Mader Hand Tools**

N. Ref.	Especificação	Quant.	Caixa:
99055	10 L	25	
99056	15 L	25	

# MADER®

## HAND TOOLS



Robot: 20 m (altura)  
Paletes: 7000



Show Room: 800 m<sup>2</sup>



Desde 1971  
Área : 23.000 m<sup>2</sup>

MADER®

TRABALHA COMO UM **PROFISSIONAL**

**M MADER®**

**M MADEIRA®**  
MADEIRA & MADEIRA

Zona Industrial da Pedrulha, lote 13  
3050-183 Casal Comba | Mealhada, Portugal  
Apartado 100, 3050-901 Mealhada

T. +351 231 200 200  
F. +351 231 200 201  
Tm. +351 919 854 879  
geral@mader.pt  
www.mader.pt



PME líder'22



Management  
System  
ISO 9001:2015

www.tuv.com  
ID: 9105073648